

CHAPTER 3

USE AND OCCUPANCY CLASSIFICATION

SECTION 301 GENERAL

301.1 Scope. The provisions of this chapter shall control the classification of all buildings and structures as to use and occupancy.

SECTION 302 CLASSIFICATION

302.1 General. Structures or portions of structures shall be classified with respect to occupancy in one or more of the groups listed below. A room or space that is intended to be occupied at different times for different purposes shall comply with all of the requirements that are applicable to each of the purposes for which the room or space will be occupied. Structures with multiple occupancies or uses shall comply with Section 508. Where a structure is proposed for a purpose that is not specifically provided for in this code, such structure shall be classified in the group that the occupancy most nearly resembles, according to the fire safety and relative hazard involved.

1. Assembly (see Section 303): Groups A-1, A-2, A-3, A-4 and A-5
2. Business (see Section 304): Group B
3. Educational (see Section 305): Group E
4. Factory and Industrial (see Section 306): Groups F-1 and F-2
5. High Hazard (see Section 307): Groups H-1, H-2, H-3, H-4 and H-5
6. Institutional (see Section 308): Groups I-1, I-2, I-3 and I-4
7. Mercantile (see Section 309): Group M
8. Residential (see Section 310): Groups R-1, R-2, R-3 and R-4
9. Storage (see Section 311): Groups S-1 and S-2
10. Utility and Miscellaneous (see Section 312): Group U

SECTION 303 ASSEMBLY GROUP A

303.1 Assembly Group A. Assembly Group A occupancy includes, among others, the use of a building or structure, or a portion thereof, for the gathering of persons for purposes such as civic, social or religious functions; recreation, food or drink consumption or awaiting transportation.

Exceptions:

1. A building or tenant space used for assembly purposes with an *occupant load* of less than 50 persons shall be classified as a Group B occupancy.

2. A room or space used for assembly purposes with an *occupant load* of less than 50 persons and accessory to another occupancy shall be classified as a Group B occupancy or as part of that occupancy.
3. A room or space used for assembly purposes that is less than 750 square feet (70 m²) in area and accessory to another occupancy shall be classified as a Group B occupancy or as part of that occupancy.
4. Assembly areas that are accessory to Group E occupancies are not considered separate occupancies except when applying the assembly occupancy requirements of Chapter 11.
5. Accessory religious educational rooms and religious auditoriums with occupant loads of less than 100 are not considered separate occupancies.

Assembly occupancies shall include the following:

A-1 Assembly uses, usually with fixed seating, intended for the production and viewing of the performing arts or motion pictures including, but not limited to:

Motion picture theaters
Symphony and concert halls
Television and radio studios admitting an audience
Theaters

A-2 Assembly uses intended for food and/or drink consumption including, but not limited to:

Banquet halls
Night clubs
Restaurants
Taverns and bars

A-3 Assembly uses intended for worship, recreation or amusement and other assembly uses not classified elsewhere in Group A including, but not limited to:

Amusement arcades
Art galleries
Bowling alleys
Community halls
Courtrooms
Dance halls (not including food or drink consumption)
Exhibition halls
Funeral parlors
Gymnasiums (without spectator seating)
Indoor swimming pools (without spectator seating)
Indoor tennis courts (without spectator seating)
Lecture halls
Libraries
Museums
Places of religious worship
Pool and billiard parlors
Waiting areas in transportation terminals

USE AND OCCUPANCY CLASSIFICATION

A-4 Assembly uses intended for viewing of indoor sporting events and activities with spectator seating including, but not limited to:

- Arenas
- Skating rinks
- Swimming pools
- Tennis courts

A-5 Assembly uses intended for participation in or viewing outdoor activities including, but not limited to:

- Amusement park structures
- Bleachers
- Grandstands
- Stadiums

SECTION 304 BUSINESS GROUP B

304.1 Business Group B. Business Group B occupancy includes, among others, the use of a building or structure, or a portion thereof, for office, professional or service-type transactions, including storage of records and accounts. Business occupancies shall include, but not be limited to, the following:

- Airport traffic control towers
- Ambulatory health care facilities
- Animal hospitals, kennels and pounds
- Banks
- Barber and beauty shops
- Car wash
- Civic administration
- Clinic—outpatient
- Dry cleaning and laundries: pick-up and delivery stations and self-service
- Educational occupancies for students above the 12th grade
- Electronic data processing
- Laboratories: testing and research
- Motor vehicle showrooms
- Post offices
- Print shops
- Professional services (architects, attorneys, dentists, physicians, engineers, etc.)
- Radio and television stations
- Telephone exchanges
- Training and skill development not within a school or academic program

304.1.1 Definitions. The following words and terms shall, for the purposes of this section and as used elsewhere in this code, have the meanings shown herein.

CLINIC, OUTPATIENT. Buildings or portions thereof used to provide medical care on less than a 24-hour basis to individuals who are not rendered incapable of self-preservation by the services provided.

SECTION 305 EDUCATIONAL GROUP E

305.1 Educational Group E. Educational Group E occupancy includes, among others, the use of a building or structure, or a

portion thereof, by six or more persons at any one time for educational purposes through the 12th grade. Religious educational rooms and religious auditoriums, which are accessory to *places of religious worship* in accordance with Section 303.1 and have *occupant loads* of less than 100, shall be classified as Group A-3 occupancies.

305.2 Day care. The use of a building or structure, or portion thereof, for educational, supervision or *personal care services* for more than five children older than 2½ years of age, shall be classified as a Group E occupancy.

SECTION 306 FACTORY GROUP F

306.1 Factory Industrial Group F. Factory Industrial Group F occupancy includes, among others, the use of a building or structure, or a portion thereof, for assembling, disassembling, fabricating, finishing, manufacturing, packaging, repair or processing operations that are not classified as a Group H hazardous or Group S storage occupancy.

306.2 Factory Industrial F-1 Moderate-hazard Occupancy. Factory industrial uses which are not classified as Factory Industrial F-2 Low Hazard shall be classified as F-1 Moderate Hazard and shall include, but not be limited to, the following:

- Aircraft (manufacturing, not to include repair)
- Appliances
- Athletic equipment
- Automobiles and other motor vehicles
- Bakeries
- Beverages: over 16-percent alcohol content
- Bicycles
- Boats
- Brooms or brushes
- Business machines
- Cameras and photo equipment
- Canvas or similar fabric
- Carpets and rugs (includes cleaning)
- Clothing
- Construction and agricultural machinery
- Disinfectants
- Dry cleaning and dyeing
- Electric generation plants
- Electronics
- Engines (including rebuilding)
- Food processing
- Furniture
- Hemp products
- Jute products
- Laundries
- Leather products
- Machinery
- Metals
- Millwork (sash and door)
- Motion pictures and television filming (without spectators)
- Musical instruments
- Optical goods
- Paper mills or products
- Photographic film

Plastic products
 Printing or publishing
 Recreational vehicles
 Refuse incineration
 Shoes
 Soaps and detergents
 Textiles
 Tobacco
 Trailers
 Upholstering
 Wood; distillation
 Woodworking (cabinet)

306.3 Factory Industrial F-2 Low-hazard Occupancy. Factory industrial uses that involve the fabrication or manufacturing of noncombustible materials which during finishing, packing or processing do not involve a significant fire hazard shall be classified as F-2 occupancies and shall include, but not be limited to, the following:

Beverages: up to and including 16-percent alcohol content
 Brick and masonry
 Ceramic products
 Foundries
 Glass products
 Gypsum
 Ice
 Metal products (fabrication and assembly)

**SECTION 307
 HIGH-HAZARD GROUP H**

[F] **307.1 High-hazard Group H.** High-hazard Group H occupancy includes, among others, the use of a building or structure, or a portion thereof, that involves the manufacturing, processing, generation or storage of materials that constitute a physical or health hazard in quantities in excess of those allowed in *control areas* complying with Section 414, based on the maximum allowable quantity limits for control areas set forth in Tables 307.1(1) and 307.1(2). Hazardous occupancies are classified in Groups H-1, H-2, H-3, H-4 and H-5 and shall be in accordance with this section, the requirements of Section 415 and the *International Fire Code*. Hazardous materials stored, or used on top of roofs or canopies shall be classified as outdoor storage or use and shall comply with the *International Fire Code*.

Exceptions: The following shall not be classified as Group H, but shall be classified as the occupancy that they most nearly resemble.

- 1. Buildings and structures occupied for the application of flammable finishes, provided that such buildings or areas conform to the requirements of Section 416 and the *International Fire Code*.

- 2. Wholesale and retail sales and storage of flammable and combustible liquids in mercantile occupancies conforming to the *International Fire Code*.
- 3. Closed piping system containing flammable or combustible liquids or gases utilized for the operation of machinery or equipment.
- 4. Cleaning establishments that utilize combustible liquid solvents having a flash point of 140°F (60°C) or higher in closed systems employing equipment listed by an *approved* testing agency, provided that this occupancy is separated from all other areas of the building by 1-hour *fire barriers* constructed in accordance with Section 707 or 1-hour *horizontal assemblies* constructed in accordance with Section 712, or both.
- 5. Cleaning establishments that utilize a liquid solvent having a flash point at or above 200°F (93°C).
- 6. Liquor stores and distributors without bulk storage.
- 7. Refrigeration systems.
- 8. The storage or utilization of materials for agricultural purposes on the premises.
- 9. Stationary batteries utilized for facility emergency power, uninterrupted power supply or telecommunication facilities, provided that the batteries are provided with safety venting caps and ventilation is provided in accordance with the *International Mechanical Code*.
- 10. Corrosives shall not include personal or household products in their original packaging used in retail display or commonly used building materials.
- 11. Buildings and structures occupied for aerosol storage shall be classified as Group S-1, provided that such buildings conform to the requirements of the *International Fire Code*.
- 12. Display and storage of nonflammable solid and nonflammable or noncombustible liquid hazardous materials in quantities not exceeding the maximum allowable quantity per *control area* in Group M or S occupancies complying with Section 414.2.5.
- 13. The storage of black powder, smokeless propellant and small arms primers in Groups M, R-3 and R-5 and special industrial explosive devices in Groups B, F, M and S, provided such storage conforms to the quantity limits and requirements prescribed in the *International Fire Code*, as amended in Section 307.9.

[F] TABLE 307.1(1) MAXIMUM ALLOWABLE QUANTITY PER CONTROL AREA OF HAZARDOUS MATERIALS POSING A PHYSICAL HAZARD^{a, j, m, n, p}

MATERIAL	CLASS	GROUP WHEN THE MAXIMUM ALLOWABLE QUANTITY IS EXCEEDED	STORAGE ^b			USE-CLOSED SYSTEMS ^b			USE-OPEN SYSTEMS ^b		
			Solid pounds (cubic feet)	Liquid gallons (pounds)	Gas (cubic feet at NTP)	Solid pounds (cubic feet)	Liquid gallons (pounds)	Gas (cubic feet at NTP)	Solid pounds (cubic feet)	Liquid gallons (pounds)	Gas (cubic feet at NTP)
Combustible liquid ^{c, i}	II	H-2 or H-3	N/A	120 ^{d, e}	N/A	N/A	N/A	120 ^d	N/A	N/A	30 ^d
	IIIA	H-2 or H-3	N/A	330 ^{d, e}	N/A	N/A	N/A	330 ^d	N/A	N/A	80 ^d
	IIIB	N/A	N/A	13,200 ^{e, f}	N/A	N/A	N/A	13,200 ^f	N/A	N/A	3,300 ^f
Combustible fiber	Loose Baled ^o	H-3	(100) (1,000)	N/A	N/A	N/A	(100) (1,000)	N/A	N/A	N/A	N/A
		H-3	125 ^{d, e, 1}	N/A	N/A	N/A	N/A	N/A	N/A	N/A	N/A
Consumer fireworks (Class C, Common)	1.4G	H-3	125 ^{d, e, 1}	N/A	N/A	N/A	N/A	N/A	N/A	N/A	N/A
Cryogenics, flammable	N/A	H-2	N/A	45 ^d	N/A	N/A	N/A	45 ^d	N/A	N/A	10 ^d
	N/A	N/A	N/A	N/A	NL	NL	N/A	N/A	NL	N/A	N/A
	N/A	H-3	N/A	45 ^d	N/A	N/A	N/A	45 ^d	N/A	N/A	10 ^d
Explosives	Division 1.1	H-1	1 ^{c, g}	(1) ^{c, g}	N/A	N/A	0.25 ^g	(0.25) ^g	N/A	N/A	(0.25) ^g
	Division 1.2	H-1	1 ^{c, g}	(1) ^{c, g}	N/A	N/A	0.25 ^g	(0.25) ^g	N/A	N/A	(0.25) ^g
	Division 1.3	H-1 or H-2	5 ^{c, g}	(5) ^{c, g}	N/A	N/A	1 ^g	(1) ^g	N/A	N/A	1 ^g
	Division 1.4	H-3	50 ^{c, g}	(50) ^{c, g}	N/A	N/A	50 ^g	(50) ^g	N/A	N/A	N/A
	Division 1.4G	H-3	125 ^{d, e, 1}	N/A	N/A	N/A	N/A	N/A	N/A	N/A	N/A
	Division 1.5	H-1	1 ^{c, g}	(1) ^{c, g}	N/A	N/A	0.25 ^g	(0.25) ^g	N/A	N/A	(0.25) ^g
Division 1.6	H-1	1 ^{d, e, g}	N/A	N/A	N/A	N/A	N/A	N/A	N/A	N/A	
Flammable gas	Gaseous Liquefied	H-2	N/A	N/A (150) ^{d, e}	1,000 ^{d, e} N/A	N/A	N/A	N/A	1,000 ^{d, e} N/A	N/A	N/A
Flammable liquid ^c	1A 1B and 1C	H-2 or H-3	N/A	30 ^{d, e} 120 ^{d, e}	N/A	N/A	N/A	30 ^d 120 ^d	N/A	N/A	10 ^d 30 ^d
		H-2 or H-3	N/A	120 ^{d, e, h}	N/A	N/A	N/A	120 ^{d, h}	N/A	N/A	30 ^{d, h}
Flammable solid	N/A	H-3	125 ^{d, e}	N/A	N/A	N/A	125 ^d	N/A	N/A	N/A	25 ^d
		N/A	N/A	N/A	NL	NL	N/A	N/A	NL	N/A	N/A
Organic peroxide	UD I II III IV V	H-1	1 ^{c, g}	(1) ^{c, g}	N/A	N/A	0.25 ^g	(0.25) ^g	N/A	N/A	(0.25) ^g
		H-2	5 ^{d, e}	(5) ^{d, e}	N/A	N/A	1 ^d	(1) ^d	N/A	N/A	1 ^d
		H-3	50 ^{d, e}	(50) ^{d, e}	N/A	N/A	50 ^d	(50) ^d	N/A	N/A	10 ^d
		H-3	125 ^{d, e}	(125) ^{d, e}	N/A	N/A	125 ^d	(125) ^d	N/A	N/A	25 ^d
		N/A	NL	NL	N/A	NL	NL	N/A	NL	N/A	NL
Oxidizer	4 3 ^k 2 1	H-1	1 ^{c, g}	(1) ^{c, g}	N/A	N/A	0.25 ^g	(0.25) ^g	N/A	N/A	(0.25) ^g
		H-2 or H-3	10 ^{d, e}	(10) ^{d, e}	N/A	N/A	2 ^d	(2) ^d	N/A	N/A	2 ^d
		H-3	250 ^{d, e}	(250) ^{d, e}	N/A	N/A	250 ^d	(250) ^d	N/A	N/A	50 ^d
		N/A	4,000 ^{e, f}	(4,000) ^{e, f}	N/A	N/A	4,000 ^f	(4,000) ^f	N/A	N/A	1,000 ^f

(continued)

[F] TABLE 307.1(1)—Continued
 MAXIMUM ALLOWABLE QUANTITY PER CONTROL AREA OF HAZARDOUS MATERIALS POSING A PHYSICAL HAZARD^{a, j, m, n, p}

MATERIAL	CLASS	GROUP WHEN THE MAXIMUM ALLOWABLE QUANTITY IS EXCEEDED	STORAGE ^b			USE-CLOSED SYSTEMS ^b			USE-OPEN SYSTEMS ^b		
			Solid pounds (cubic feet)	Liquid gallons (pounds)	Gas (cubic feet at NTP)	Solid pounds (cubic feet)	Liquid gallons (pounds)	Gas (cubic feet at NTP)	Solid pounds (cubic feet)	Liquid gallons (pounds)	Liquid gallons (pounds)
			Oxidizing gas	Gaseous Liquefied	H-3	N/A N/A	N/A (150) ^{d, e}	1,500 ^{d, e} N/A	N/A N/A	N/A N/A	N/A (150) ^{d, e}
Pyrophoric material	N/A	H-2	4 ^{g, g}	(4) ^{e, g}	50 ^{g, g}	1 ^g	1 ^g	(1) ^g	10 ^g	0	0
Unstable (reactive)	4	H-1	1 ^{e, g}	(1) ^{e, g}	10 ^g	0.25 ^g	0.25 ^g	(0.25) ^g	2 ^{e, g}	0.25 ^g	(0.25) ^g
	3	H-1 or H-2	5 ^{d, e}	(5) ^{d, e}	50 ^{d, e}	1 ^d	1 ^d	(1) ^d	10 ^{d, e}	1 ^d	(1) ^d
	2	H-3	50 ^{d, e}	(50) ^{d, e}	250 ^{d, e}	50 ^d	50 ^d	(50) ^d	250 ^{d, e}	10 ^d	(10) ^d
Water reactive	1	N/A	NL	NL	NL	NL	NL	NL	NL	NL	NL
	3	H-2	5 ^{d, e}	(5) ^{d, e}	N/A	5 ^d	5 ^d	(5) ^d	N/A	1 ^d	(1) ^d
	2	H-3	50 ^{d, e}	(50) ^{d, e}	N/A	50 ^d	50 ^d	(50) ^d	N/A	10 ^d	(10) ^d
1	N/A	NL	NL	N/A	NL	NL	NL	N/A	NL	NL	

For SI: 1 cubic foot = 0.028 m³, 1 pound = 0.454 kg, 1 gallon = 3.785 L.
 NL = Not Limited; N/A = Not Applicable; UD = Unclassified Detonable
 a. For use of *control areas*, see Section 414.2.
 b. The aggregate quantity in use and storage shall not exceed the quantity listed for storage.
 c. The quantities of alcoholic beverages in retail and wholesale sales occupancies shall not be limited providing the liquids are packaged in individual containers not exceeding 1.3 gallons. In retail and wholesale sales occupancies, the quantities of medicines, foodstuffs, consumer or industrial products, and cosmetics containing not more than 50 percent by volume of water-miscible liquids with the remainder of the solutions not being flammable, shall not be limited, provided that such materials are packaged in individual containers not exceeding 1.3 gallons.
 d. Maximum allowable quantities shall be increased 100 percent in buildings equipped throughout with an *automatic sprinkler system* in accordance with Section 903.3.1.1. Where Note e also applies, the increase for both notes shall be applied accumulatively.
 e. Maximum allowable quantities shall be increased 100 percent when stored in *approved* storage cabinets, day boxes, gas cabinets or exhausted enclosures or in *listed* safety cans in accordance with Section 2703.9.10 of the *International Fire Code*. Where Note d also applies, the increase for both notes shall be applied accumulatively.
 f. The permitted quantities shall not be limited in a building equipped throughout with an *automatic sprinkler system* in accordance with Section 903.3.1.1.
 g. Permitted only in buildings equipped throughout with an *automatic sprinkler system* in accordance with Section 903.3.1.1.
 h. Containing not more than the maximum allowable quantity per *control area* of Class IA, IB or IC flammable liquids.
 i. The maximum allowable quantity shall not apply to fuel oil storage complying with Section 603.3.2 of the *International Fire Code*.
 j. Quantities in parenthesis indicate quantity units in parenthesis at the head of each column.
 k. A maximum quantity of 200 pounds of solid or 20 gallons of liquid Class 3 oxidizers is allowed when such materials are necessary for maintenance purposes, operation or sanitation of equipment. Storage containers and the manner of storage shall be approved.
 l. Net weight of the pyrotechnic composition of the fireworks. Where the net weight of the pyrotechnic composition of the fireworks is not known, 25 percent of the gross weight of the fireworks, including packaging, shall be used.
 m. For gallons of liquids, divide the amount in pounds by 10 in accordance with Section 2703.1.2 of the *International Fire Code*.
 n. For storage and display quantities in Group M and storage quantities in Group S occupancies complying with Section 414.2.5, see Tables 414.2.5(1) and 414.2.5(2).
 o. Densely packed baled cotton that complies with the packing requirements of ISO 8115 shall not be included in this material class.
 p. The following shall not be included in determining the maximum allowable quantities:
 1. Liquid or gaseous fuel in fuel tanks on vehicles.
 2. Liquid or gaseous fuel in fuel tanks on motorized equipment operated in accordance with this code.
 3. Gaseous fuels in piping systems and fixed appliances regulated by the *International Fuel Gas Code*.
 4. Liquid fuels in piping systems and fixed appliances regulated by the *International Mechanical Code*.

[F] TABLE 307.1(2)
 MAXIMUM ALLOWABLE QUANTITY PER CONTROL AREA OF HAZARDOUS MATERIAL POSING A HEALTH HAZARD^{a, b, c, i}

MATERIAL	STORAGE ^d			USE-CLOSED SYSTEMS ^d			USE-OPEN SYSTEMS ^d	
	Solid pounds (cubic feet)	Liquid gallons (pounds) ^{e, f}	Gas (cubic feet at NTP) ^e	Solid pounds ^e	Liquid gallons (pounds) ^e	Gas (cubic feet at NTP) ^e	Solid pounds ^e	Liquid gallons (pounds) ^e
Corrosive	5,000	500	Gaseous 810 ^f Liquefied (150) ^h	5,000	500	Gaseous 810 ^f Liquefied (150) ^h	1,000	100
Highly toxic	10	(10) ^h	Gaseous 20 ^g Liquefied (4) ^{g, h}	10	(10) ⁱ	Gaseous 20 ^g Liquefied (4) ^{g, h}	3	(3) ⁱ
Toxic	500	(500) ^h	Gaseous 810 ^f Liquefied (150) ^{f, h}	500	(500) ⁱ	Gaseous 810 ^f Liquefied (150) ^{f, h}	125	(125)

For SI: 1 cubic foot = 0.028 m³, 1 pound = 0.454 kg, 1 gallon = 3.785 L.

- a. For use of control areas, see Section 414.2.
- b. In retail and wholesale sales occupancies, the quantities of medicines, foodstuffs, consumer or industrial products, and cosmetics, containing not more than 50 percent by volume of water-miscible liquids and with the remainder of the solutions not being flammable, shall not be limited, provided that such materials are packaged in individual containers not exceeding 1.3 gallons.
- c. For storage and display quantities in Group M and storage quantities in Group S occupancies complying with Section 414.2.5, see Tables 414.2.5(1) and 414.2.5(2).
- d. The aggregate quantity in use and storage shall not exceed the quantity listed for storage.
- e. Maximum allowable quantities shall be increased 100 percent in buildings equipped throughout with an approved automatic sprinkler system in accordance with Section 903.3.1.1. Where Note f also applies, the increase for both notes shall be applied accumulatively.
- f. Maximum allowable quantities shall be increased 100 percent when stored in approved storage cabinets, gas cabinets or exhausted enclosures as specified in the *International Fire Code*. Where Note e also applies, the increase for both notes shall be applied accumulatively.
- g. Allowed only when stored in approved exhausted gas cabinets or exhausted enclosures as specified in the *International Fire Code*.
- h. Quantities in parenthesis indicate quantity units in parenthesis at the head of each column.
- i. For gallons of liquids, divide the amount in pounds by 10 in accordance with Section 2703.1.2 of the *International Fire Code*.

307.1.1 Hazardous materials. Hazardous materials in any quantity shall conform to the requirements of this code, including Section 414, and the *International Fire Code*.

[F] **307.2 Definitions.** The following words and terms shall, for the purposes of this section and as used elsewhere in this code, have the meanings shown herein.

AEROSOL. A product that is dispensed from an aerosol container by a propellant.

Aerosol products shall be classified by means of the calculation of their chemical heats of combustion and shall be designated Level 1, 2 or 3.

Level 1 aerosol products. Those with a total chemical heat of combustion that is less than or equal to 8,600 British thermal units per pound (Btu/lb) (20 kJ/g).

Level 2 aerosol products. Those with a total chemical heat of combustion that is greater than 8,600 Btu/lb (20 kJ/g), but less than or equal to 13,000 Btu/lb (30 kJ/g).

Level 3 aerosol products. Those with a total chemical heat of combustion that is greater than 13,000 Btu/lb (30 kJ/g).

AEROSOL CONTAINER. A metal can or a glass or plastic bottle designed to dispense an aerosol. Metal cans shall be limited to a maximum size of 33.8 fluid ounces (1000 ml). Glass or plastic bottles shall be limited to a maximum size of 4 fluid ounces (118 ml).

BALED COTTON. A natural seed fiber wrapped in and secured with industry accepted materials, usually consisting of burlap, woven polypropylene, polyethylene or cotton or sheet polyethylene, and secured with steel, synthetic or wire bands or

wire; also includes linters (lint removed from the cottonseed) and motes (residual materials from the ginning process).

BALED COTTON, DENSELY PACKED. Cotton made into banded bales with a packing density of at least 22 pounds per cubic foot (360 kg/m³), and dimensions complying with the following: a length of 55 inches (1397 ± 20 mm), a width of 21 inches (533.4 ± 20 mm) and a height of 27.6 to 35.4 inches (701 to 899 mm).

BARRICADE. A structure that consists of a combination of walls, floor and roof, which is designed to withstand the rapid release of energy in an explosion and which is fully confined, partially vented or fully vented; or other effective method of shielding from explosive materials by a natural or artificial barrier.

Artificial barricade. An artificial mound or revetment a minimum thickness of 3 feet (914 mm).

Natural barricade. Natural features of the ground, such as hills, or timber of sufficient density that the surrounding exposures that require protection cannot be seen from the magazine or building containing explosives when the trees are bare of leaves.

BOILING POINT. The temperature at which the vapor pressure of a liquid equals the atmospheric pressure of 14.7 pounds per square inch (psi) (101 kPa) gage or 760 mm of mercury. Where an accurate boiling point is unavailable for the material in question, or for mixtures which do not have a constant boiling point, for the purposes of this classification, the 20-percent evaporated point of a distillation performed in accordance with ASTM D 86 shall be used as the boiling point of the liquid.

CLOSED SYSTEM. The use of a solid or liquid hazardous material involving a closed vessel or system that remains closed during normal operations where vapors emitted by the product are not liberated outside of the vessel or system and the product is not exposed to the atmosphere during normal operations; and all uses of compressed gases. Examples of closed systems for solids and liquids include product conveyed through a piping system into a closed vessel, system or piece of equipment.

COMBUSTIBLE DUST. Finely divided solid material that is 420 microns or less in diameter and which, when dispersed in air in the proper proportions, could be ignited by a flame, spark or other source of ignition. Combustible dust will pass through a U.S. No. 40 standard sieve.

COMBUSTIBLE FIBERS. Readily ignitable and free-burning materials in a fibrous or shredded form, such as cocoa fiber, cloth, cotton, excelsior, hay, hemp, henequen, istle, jute, kapok, oakum, rags, sisal, Spanish moss, straw, tow, wastepaper, certain synthetic fibers or other like materials. This definition does not include densely packed baled cotton.

COMBUSTIBLE LIQUID. A liquid having a closed cup flash point at or above 100°F (38°C). Combustible liquids shall be subdivided as follows:

Class II. Liquids having a closed cup flash point at or above 100°F (38°C) and below 140°F (60°C).

Class IIIA. Liquids having a closed cup flash point at or above 140°F (60°C) and below 200°F (93°C).

Class IIIB. Liquids having a closed cup flash point at or above 200°F (93°C).

The category of combustible liquids does not include compressed gases or cryogenic fluids.

COMPRESSED GAS. A material, or mixture of materials, that:

1. Is a gas at 68°F (20°C) or less at 14.7 pounds per square inch atmosphere (psia) (101 kPa) of pressure; and
2. Has a boiling point of 68°F (20°C) or less at 14.7 psia (101 kPa) which is either liquefied, nonliquefied or in solution, except those gases which have no other health- or physical-hazard properties are not considered to be compressed until the pressure in the packaging exceeds 41 psia (282 kPa) at 68°F (20°C).

The states of a compressed gas are categorized as follows:

1. Nonliquefied compressed gases are gases, other than those in solution, which are in a packaging under the charged pressure and are entirely gaseous at a temperature of 68°F (20°C).
2. Liquefied compressed gases are gases that, in a packaging under the charged pressure, are partially liquid at a temperature of 68°F (20°C).
3. Compressed gases in solution are nonliquefied gases that are dissolved in a solvent.
4. Compressed gas mixtures consist of a mixture of two or more compressed gases contained in a packaging, the

hazard properties of which are represented by the properties of the mixture as a whole.

CONTROL AREA. Spaces within a building where quantities of hazardous materials not exceeding the maximum allowable quantities per *control area* are stored, dispensed, used or handled. See also the definition of “Outdoor control area” in the *International Fire Code*.

CORROSIVE. A chemical that causes visible destruction of, or irreversible alterations in, living tissue by chemical action at the point of contact. A chemical shall be considered corrosive if, when tested on the intact skin of albino rabbits by the method described in DOTn 49 CFR, Part 173.137, such a chemical destroys or changes irreversibly the structure of the tissue at the point of contact following an exposure period of 4 hours. This term does not refer to action on inanimate surfaces.

CRYOGENIC FLUID. A liquid having a boiling point lower than -130°F (-89.9°C) at 14.7 pounds per square inch atmosphere (psia) (an absolute pressure of 101 kPa).

DAY BOX. A portable magazine designed to hold explosive materials constructed in accordance with the requirements for a Type 3 magazine as defined and classified in Chapter 33 of the *International Fire Code*.

DEFLAGRATION. An exothermic reaction, such as the extremely rapid oxidation of a flammable dust or vapor in air, in which the reaction progresses through the unburned material at a rate less than the velocity of sound. A deflagration can have an explosive effect.

DETONATION. An exothermic reaction characterized by the presence of a shock wave in the material which establishes and maintains the reaction. The reaction zone progresses through the material at a rate greater than the velocity of sound. The principal heating mechanism is one of shock compression. Detonations have an explosive effect.

DISPENSING. The pouring or transferring of any material from a container, tank or similar vessel, whereby vapors, dusts, fumes, mists or gases are liberated to the atmosphere.

EXPLOSION. An effect produced by the sudden violent expansion of gases, which may be accompanied by a shock wave or disruption, or both, of enclosing materials or structures. An explosion could result from any of the following:

1. Chemical changes such as rapid oxidation, *deflagration* or *detonation*, decomposition of molecules and runaway polymerization (usually *detonations*).
2. Physical changes such as pressure tank ruptures.
3. Atomic changes (nuclear fission or fusion).

EXPLOSIVE. A chemical compound, mixture or device, the primary or common purpose of which is to function by explosion. The term includes, but is not limited to, dynamite, black powder, pellet powder, initiating explosives, detonators, safety fuses, squibs, detonating cord, igniter cord, igniters and display fireworks, 1.3G (Class B, Special).

The term “explosive” includes any material determined to be within the scope of USC Title 18: Chapter 40 and also includes any material classified as an explosive other than consumer

fireworks, 1.4G (Class C, Common) by the hazardous materials regulations of DOTn 49 CFR, Parts 100-185.

High explosive. Explosive material, such as dynamite, which can be caused to detonate by means of a No. 8 test blasting cap when unconfined.

Low explosive. Explosive material that will burn or deflagrate when ignited. It is characterized by a rate of reaction that is less than the speed of sound. Examples of low explosives include, but are not limited to, black powder; safety fuse; igniters; igniter cord; fuse lighters; fireworks, 1.3G (Class B, Special) and propellants, 1.3C.

Mass-detonating explosives. Division 1.1, 1.2 and 1.5 explosives alone or in combination, or loaded into various types of ammunition or containers, most of which can be expected to explode virtually instantaneously when a small portion is subjected to fire, severe concussion, impact, the impulse of an initiating agent or the effect of a considerable discharge of energy from without. Materials that react in this manner represent a mass explosion hazard. Such an explosive will normally cause severe structural damage to adjacent objects. Explosive propagation could occur immediately to other items of ammunition and explosives stored sufficiently close to and not adequately protected from the initially exploding pile with a time interval short enough so that two or more quantities must be considered as one for quantity-distance purposes.

UN/DOTn Class 1 explosives. The former classification system used by DOTn included the terms “high” and “low” explosives as defined herein. The following terms further define explosives under the current system applied by DOTn for all explosive materials defined as hazard Class 1 materials. Compatibility group letters are used in concert with the division to specify further limitations on each division noted (i.e., the letter G identifies the material as a pyrotechnic substance or article containing a pyrotechnic substance and similar materials).

Division 1.1. Explosives that have a mass explosion hazard. A mass explosion is one which affects almost the entire load instantaneously.

Division 1.2. Explosives that have a projection hazard but not a mass explosion hazard.

Division 1.3. Explosives that have a fire hazard and either a minor blast hazard or a minor projection hazard or both, but not a mass explosion hazard.

Division 1.4. Explosives that pose a minor explosion hazard. The explosive effects are largely confined to the package and no projection of fragments of appreciable size or range is to be expected. An external fire must not cause virtually instantaneous explosion of almost the entire contents of the package.

Division 1.5. Very insensitive explosives. This division is comprised of substances that have a mass explosion hazard, but that are so insensitive there is very little probability of initiation or of transition from burning to *detonation* under normal conditions of transport.

Division 1.6. Extremely insensitive articles which do not have a mass explosion hazard. This division is comprised of articles that contain only extremely insensitive detonating substances and which demonstrate a negligible probability of accidental initiation or propagation.

FIREWORKS. Any composition or device for the purpose of producing a visible or audible effect for entertainment purposes by combustion, deflagration or *detonation* that meets the definition of 1.4G fireworks or 1.3G fireworks as set forth herein.

Fireworks, 1.3G. (Formerly Class B, Special Fireworks.) Large fireworks devices, which are explosive materials, intended for use in fireworks displays and designed to produce audible or visible effects by combustion, deflagration or *detonation*. Such 1.3G fireworks include, but are not limited to, firecrackers containing more than 130 milligrams (2 grains) of explosive composition, aerial shells containing more than 40 grams (617 grains) of pyrotechnic composition, and other display pieces which exceed the limits for classification as 1.4G fireworks. Such 1.3G fireworks are also described as fireworks, UN0335 by the DOTn.

Fireworks, 1.4G. (Formerly Class C, Common Fireworks.) Small fireworks devices containing restricted amounts of pyrotechnic composition designed primarily to produce visible or audible effects by combustion. Such 1.4G fireworks which comply with the construction, chemical composition and labeling regulations of the DOTn for fireworks, UN0336, and the U.S. Consumer Product Safety Commission (CPSC) as set forth in CPSC 16 CFR: Parts 1500 and 1507, are not explosive materials for the purpose of this code.

FLAMMABLE GAS. A material that is a gas at 68°F (20°C) or less at 14.7 pounds per square inch atmosphere (psia) (101 kPa) of pressure [a material that has a boiling point of 68°F (20°C) or less at 14.7 psia (101 kPa)] which:

1. Is ignitable at 14.7 psia (101 kPa) when in a mixture of 13 percent or less by volume with air; or
2. Has a flammable range at 14.7 psia (101 kPa) with air of at least 12 percent, regardless of the lower limit.

The limits specified shall be determined at 14.7 psi (101 kPa) of pressure and a temperature of 68°F (20°C) in accordance with ASTM E 681.

FLAMMABLE LIQUEFIED GAS. A liquefied compressed gas which, under a charged pressure, is partially liquid at a temperature of 68°F (20°C) and which is flammable.

FLAMMABLE LIQUID. A liquid having a closed cup flash point below 100°F (38°C). Flammable liquids are further categorized into a group known as Class I liquids. The Class I category is subdivided as follows:

Class IA. Liquids having a flash point below 73°F (23°C) and a boiling point below 100°F (38°C).

Class IB. Liquids having a flash point below 73°F (23°C) and a boiling point at or above 100°F (38°C).

Class IC. Liquids having a flash point at or above 73°F (23°C) and below 100°F (38°C).

The category of flammable liquids does not include compressed gases or cryogenic fluids.

FLAMMABLE MATERIAL. A material capable of being readily ignited from common sources of heat or at a temperature of 600°F (316°C) or less.

FLAMMABLE SOLID. A solid, other than a blasting agent or explosive, that is capable of causing fire through friction, absorption or moisture, spontaneous chemical change, or retained heat from manufacturing or processing, or which has an ignition temperature below 212°F (100°C) or which burns so vigorously and persistently when ignited as to create a serious hazard. A chemical shall be considered a flammable solid as determined in accordance with the test method of CPSC 16 CFR; Part 1500.44, if it ignites and burns with a self-sustained flame at a rate greater than 0.1 inch (2.5 mm) per second along its major axis.

FLASH POINT. The minimum temperature in degrees Fahrenheit at which a liquid will give off sufficient vapors to form an ignitable mixture with air near the surface or in the container, but will not sustain combustion. The flash point of a liquid shall be determined by appropriate test procedure and apparatus as specified in ASTM D 56, ASTM D 93 or ASTM D 3278.

HANDLING. The deliberate transport by any means to a point of storage or use.

HAZARDOUS MATERIALS. Those chemicals or substances that are physical hazards or health hazards as defined and classified in this section and the *International Fire Code*, whether the materials are in usable or waste condition.

HEALTH HAZARD. A classification of a chemical for which there is statistically significant evidence that acute or chronic health effects are capable of occurring in exposed persons. The term "health hazard" includes chemicals that are *toxic* or *highly toxic*, and corrosive.

HIGHLY TOXIC. A material which produces a lethal dose or lethal concentration that falls within any of the following categories:

1. A chemical that has a median lethal dose (LD₅₀) of 50 milligrams or less per kilogram of body weight when administered orally to albino rats weighing between 200 and 300 grams each.
2. A chemical that has a median lethal dose (LD₅₀) of 200 milligrams or less per kilogram of body weight when administered by continuous contact for 24 hours (or less if death occurs within 24 hours) with the bare skin of albino rabbits weighing between 2 and 3 kilograms each.
3. A chemical that has a median lethal concentration (LC₅₀) in air of 200 parts per million by volume or less of gas or vapor, or 2 milligrams per liter or less of mist, fume or dust, when administered by continuous inhalation for 1 hour (or less if death occurs within 1 hour) to albino rats weighing between 200 and 300 grams each.

Mixtures of these materials with ordinary materials, such as water, might not warrant classification as *highly toxic*. While this system is basically simple in application, any hazard evaluation that is required for the precise categorization of this type of

material shall be performed by experienced, technically competent persons.

INCOMPATIBLE MATERIALS. Materials that, when mixed, have the potential to react in a manner that generates heat, fumes, gases or byproducts which are hazardous to life or property.

INERT GAS. A gas that is capable of reacting with other materials only under abnormal conditions such as high temperatures, pressures and similar extrinsic physical forces. Within the context of the code, inert gases do not exhibit either physical or health properties as defined (other than acting as a simple asphyxiant) or hazard properties other than those of a compressed gas. Some of the more common inert gases include argon, helium, krypton, neon, nitrogen and xenon.

OPEN SYSTEM. The use of a solid or liquid hazardous material involving a vessel or system that is continuously open to the atmosphere during normal operations and where vapors are liberated, or the product is exposed to the atmosphere during normal operations. Examples of open systems for solids and liquids include dispensing from or into open beakers or containers, dip tank and plating tank operations.

OPERATING BUILDING. A building occupied in conjunction with the manufacture, transportation or use of explosive materials. Operating buildings are separated from one another with the use of intraplant or intraline distances.

ORGANIC PEROXIDE. An organic compound that contains the bivalent -O-O- structure and which may be considered to be a structural derivative of hydrogen peroxide where one or both of the hydrogen atoms have been replaced by an organic radical. Organic peroxides can pose an explosion hazard (*detonation* or deflagration) or they can be shock sensitive. They can also decompose into various unstable compounds over an extended period of time.

Class I. Those formulations that are capable of deflagration but not *detonation*.

Class II. Those formulations that burn very rapidly and that pose a moderate reactivity hazard.

Class III. Those formulations that burn rapidly and that pose a moderate reactivity hazard.

Class IV. Those formulations that burn in the same manner as ordinary combustibles and that pose a minimal reactivity hazard.

Class V. Those formulations that burn with less intensity than ordinary combustibles or do not sustain combustion and that pose no reactivity hazard.

Unclassified detonable. Organic peroxides that are capable of *detonation*. These peroxides pose an extremely high explosion hazard through rapid explosive decomposition.

OXIDIZER. A material that readily yields oxygen or other oxidizing gas, or that readily reacts to promote or initiate combustion of combustible materials and, if heated or contaminated, can result in vigorous self-sustained decomposition.

Class 4. An oxidizer that can undergo an explosive reaction due to contamination or exposure to thermal or physical shock and that causes a severe increase in the burning rate of

combustible materials with which it comes into contact. Additionally, the oxidizer causes a severe increase in the burning rate and can cause spontaneous ignition of combustibles.

Class 3. An oxidizer that causes a severe increase in the burning rate of combustible materials with which it comes in contact.

Class 2. An oxidizer that will cause a moderate increase in the burning rate of combustible materials with which it comes in contact.

Class 1. An oxidizer that does not moderately increase the burning rate of combustible materials.

OXIDIZING GAS. A gas that can support and accelerate combustion of other materials.

PHYSICAL HAZARD. A chemical for which there is evidence that it is a combustible liquid, cryogenic fluid, explosive, flammable (solid, liquid or gas), organic peroxide (solid or liquid), oxidizer (solid or liquid), oxidizing gas, pyrophoric (solid, liquid or gas), unstable (reactive) material (solid, liquid or gas) or water-reactive material (solid or liquid).

PYROPHORIC. A chemical with an autoignition temperature in air, at or below a temperature of 130°F (54.4°C).

PYROTECHNIC COMPOSITION. A chemical mixture that produces visible light displays or sounds through a self-propagating, heat-releasing chemical reaction which is initiated by ignition.

TOXIC. A chemical falling within any of the following categories:

1. A chemical that has a median lethal dose (LD₅₀) of more than 50 milligrams per kilogram, but not more than 500 milligrams per kilogram of body weight when administered orally to albino rats weighing between 200 and 300 grams each.
2. A chemical that has a median lethal dose (LD₅₀) of more than 200 milligrams per kilogram, but not more than 1,000 milligrams per kilogram of body weight when administered by continuous contact for 24 hours (or less if death occurs within 24 hours) with the bare skin of albino rabbits weighing between 2 and 3 kilograms each.
3. A chemical that has a median lethal concentration (LC₅₀) in air of more than 200 parts per million, but not more than 2,000 parts per million by volume of gas or vapor, or more than 2 milligrams per liter but not more than 20 milligrams per liter of mist, fume or dust, when administered by continuous inhalation for 1 hour (or less if death occurs within 1 hour) to albino rats weighing between 200 and 300 grams each.

UNSTABLE (REACTIVE) MATERIAL. A material, other than an explosive, which in the pure state or as commercially produced, will vigorously polymerize, decompose, condense or become self-reactive and undergo other violent chemical changes, including explosion, when exposed to heat, friction or shock, or in the absence of an inhibitor, or in the presence of contaminants, or in contact with incompatible materials. Unstable (reactive) materials are subdivided as follows:

Class 4. Materials that in themselves are readily capable of *detonation* or explosive decomposition or explosive reaction at normal temperatures and pressures. This class includes materials that are sensitive to mechanical or localized thermal shock at normal temperatures and pressures.

Class 3. Materials that in themselves are capable of *detonation* or of explosive decomposition or explosive reaction but which require a strong initiating source or which must be heated under confinement before initiation. This class includes materials that are sensitive to thermal or mechanical shock at elevated temperatures and pressures.

Class 2. Materials that in themselves are normally unstable and readily undergo violent chemical change but do not detonate. This class includes materials that can undergo chemical change with rapid release of energy at normal temperatures and pressures, and that can undergo violent chemical change at elevated temperatures and pressures.

Class 1. Materials that in themselves are normally stable but which can become unstable at elevated temperatures and pressure.

WATER-REACTIVE MATERIAL. A material that explodes; violently reacts; produces flammable, *toxic* or other hazardous gases; or evolves enough heat to cause autoignition or ignition of combustibles upon exposure to water or moisture. Water-reactive materials are subdivided as follows:

Class 3. Materials that react explosively with water without requiring heat or confinement.

Class 2. Materials that react violently with water or have the ability to boil water. Materials that produce flammable, *toxic* or other hazardous gases or evolve enough heat to cause autoignition or ignition of combustibles upon exposure to water or moisture.

Class 1. Materials that react with water with some release of energy, but not violently.

[F] 307.3 High-hazard Group H-1. Buildings and structures containing materials that pose a *detonation* hazard shall be classified as Group H-1. Such materials shall include, but not be limited to, the following:

Detonable pyrophoric materials

Explosives:

- Division 1.1
- Division 1.2
- Division 1.3

Exception: Materials that are used and maintained in a form where either confinement or configuration will not elevate the hazard from a mass fire to mass explosion hazard shall be allowed in H-2 occupancies.

Division 1.4

Exception: Articles, including articles packaged for shipment, that are not regulated as an explosive under Bureau of Alcohol, Tobacco and Firearms regulations, or unpackaged articles used in process operations that do not propagate a *detonation* or deflagration between articles shall be allowed in H-3 occupancies.

Division 1.5
Division 1.6

Organic peroxides, unclassified detonable
Oxidizers, Class 4
Unstable (reactive) materials, Class 3 detonable and Class 4

[F] 307.4 High-hazard Group H-2. Buildings and structures containing materials that pose a deflagration hazard or a hazard from accelerated burning shall be classified as Group H-2. Such materials shall include, but not be limited to, the following:

Class I, II or IIIA flammable or combustible liquids which are used or stored in normally open containers or systems, or in closed containers or systems pressurized at more than 15 psi (103.4 kPa) gage.
Combustible dusts
Cryogenic fluids, flammable
Flammable gases
Organic peroxides, Class I
Oxidizers, Class 3, that are used or stored in normally open containers or systems, or in closed containers or systems pressurized at more than 15 psi (103 kPa) gage
Pyrophoric liquids, solids and gases, nondetonable
Unstable (reactive) materials, Class 3, nondetonable
Water-reactive materials, Class 3

[F] 307.5 High-hazard Group H-3. Buildings and structures containing materials that readily support combustion or that pose a physical hazard shall be classified as Group H-3. Such materials shall include, but not be limited to, the following:

Class I, II or IIIA flammable or combustible liquids that are used or stored in normally closed containers or systems pressurized at 15 pounds per square inch gauge (103.4 kPa) or less
Combustible fibers, other than densely packed baled cotton
Consumer fireworks, 1.4G (Class C, Common)
Cryogenic fluids, oxidizing
Flammable solids
Organic peroxides, Class II and III
Oxidizers, Class 2
Oxidizers, Class 3, that are used or stored in normally closed containers or systems pressurized at 15 pounds per square inch gauge (103 kPa) or less
Oxidizing gases
Unstable (reactive) materials, Class 2
Water-reactive materials, Class 2

[F] 307.6 High-hazard Group H-4. Buildings and structures which contain materials that are health hazards shall be classified as Group H-4. Such materials shall include, but not be limited to, the following:

Corrosives
Highly toxic materials
Toxic materials

[F] 307.7 High-hazard Group H-5 structures. Semiconductor fabrication facilities and comparable research and development areas in which hazardous production materials (HPM) are used and the aggregate quantity of materials is in excess of those listed in Tables 307.1(1) and 307.1(2) shall be classified

as Group H-5. Such facilities and areas shall be designed and constructed in accordance with Section 415.8.

[F] 307.8 Multiple hazards. Buildings and structures containing a material or materials representing hazards that are classified in one or more of Groups H-1, H-2, H-3 and H-4 shall conform to the code requirements for each of the occupancies so classified.

307.9 Amendments. The following changes shall be made to the *International Fire Code* for the use of Exception 13 in Section 307.1:

1. Change Section 314.1 of the IFC to read as follows:
 - 314.1 General.** Indoor displays constructed within any building or structure shall comply with Sections 314.2 through 314.5.
2. Add new Section 314.5 to the IFC to read as follows:
 - 314.5 Smokeless powder and small arms primers.** Vendors shall not store, display or sell smokeless powder or small arms primers during trade shows inside exhibition halls except as follows:
 1. The amount of smokeless powder each vender may store is limited to the storage arrangements and storage amounts established in Section 3306.5.2.1.
 2. Smokeless powder shall remain in the manufacturer's original sealed container and the container shall remain sealed while inside the building. The repackaging of smokeless powder shall not be performed inside the building. Damaged containers shall not be repackaged inside the building and shall be immediately removed from the building in such manner to avoid spilling any powder.
 3. There shall be at least 50 feet (15 240 mm) separation between vendors and 20 feet (6096 mm) from any exit.
 4. Small arms primers shall be displayed and stored in the manufacturer's original packaging and in accordance with the requirements of Section 3306.5.2.3.
3. Change Exception 4 and add Exceptions 10 and 11 to Section 3301.1 of the IFC as follows:
 4. The possession, storage and use of not more than 15 pounds (6.75 kg) of commercially manufactured sporting black powder, 20 pounds (9 kg) of smokeless powder and any amount of small arms primers for hand loading of small arms ammunition for personal consumption.
 10. The display of small arms primers in Group M when in the original manufacturer's packaging.
 11. The possession, storage and use of not more than 50 pounds (23 kg) of commercially manufactured sporting black powder, 100 pounds (45 kg) of smokeless powder, and small arms primers for hand loading of small arms ammunition for personal consumption in Group R-3 or R-5, or 200 pounds (91 kg) of smokeless powder when

stored in the manufacturer's original containers in detached Group U structures at least 10 feet (3048 mm) from inhabited buildings and are accessory to Group R-3 or R-5.

4. Change the definition of Smokeless Propellants in Section 3302.1 of the IFC as follows:

SMOKELESS PROPELLANTS. Solid propellants, commonly referred to as smokeless powders, or any propellants classified by DOTn as smokeless propellants in accordance with NA3178 (Smokeless Powder for Small Arms), used in small arms ammunition, firearms, cannons, rockets, propellant-actuated devices and similar articles.

5. Change Section 3306.4 of the IFC to read as follows:

3306.4 Storage in residences. Propellants for personal use in quantities not exceeding 50 pounds (23 kg) of black powder or 100 pounds (45 kg) of smokeless powder shall be stored in original containers in occupancies limited to Group R-3 and R-5 or 200 pounds (91 kg) of smokeless powder when stored in the manufacturer's original containers in detached Group U structures at least 10 feet (3048 mm) from inhabited buildings and are accessory to Group R-3 or R-5. In other than Group R-3 or R-5, smokeless powder in quantities exceeding 20 pounds (9 kg) but not exceeding 50 pounds (23 kg) shall be kept in a wooden box or cabinet having walls of at least one inch (25 mm) nominal thickness or equivalent.

6. Delete Sections 3306.4.1 and 3306.4.2 of the IFC.

7. Change Section 3306.5.1.1 of the IFC to read as follows:

3306.5.1.1 Smokeless propellant. No more than 100 pounds (45 kg) of smokeless propellants in containers of eight pounds (3.6 kg) or less capacity shall be displayed in Group M occupancies.

8. Delete Section 3306.5.1.3 of the IFC.

9. Change Section 3306.5.2.1 of the IFC as follows:

3306.5.2.1 Smokeless propellant. Commercial stocks of smokeless propellants shall be stored as follows:

1. Quantities exceeding 20 pounds (9 kg), but not exceeding 100 pounds (45 kg) shall be stored in portable wooden boxes having walls of at least one inch (25 mm) nominal thickness or equivalent.
2. Quantities exceeding 100 pounds (45 kg), but not exceeding 800 pounds (363 kg), shall be stored in storage cabinets having walls at least one inch (25 mm) nominal thickness or equivalent. Not more than 400 pounds (182 kg) shall be stored in any one cabinet, and cabinets shall be separated by a distance of at least 25 feet (7620 mm) or by a fire partition having a fire-resistance rating of at least 1 hour.
3. Storage of quantities exceeding 800 pounds (363 kg), but not exceeding 5,000 pounds

(2270 kg) in a building shall comply with all of the following:

- 3.1. The storage is inaccessible to unauthorized personnel.
 - 3.2. Smokeless propellant shall be stored in nonportable storage cabinets having wood walls at least one inch (25 mm) nominal thickness or equivalent and having shelves with no more than 3 feet (914 mm) of vertical separation between shelves.
 - 3.3. No more than 400 pounds (182 kg) is stored in any one cabinet.
 - 3.4. Cabinets shall be located against walls with at least 40 feet (12 192 mm) between cabinets. The minimum required separation between cabinets may be reduced to 20 feet (6096 mm) provided that barricades twice the height of the cabinets are attached to the wall, midway between each cabinet. The barricades must extend a minimum of 10 feet (3048 mm) outward, be firmly attached to the wall, and be constructed of steel not less than 0.25 inch thick (6.4 mm), 2-inch (51 mm) nominal thickness wood, brick, or concrete block.
 - 3.5. Smokeless propellant shall be separated from materials classified as combustible liquids, flammable liquids, flammable solids, or oxidizing materials by a distance of 25 feet (7620 mm) or by a fire partition having a fire-resistance rating of 1 hour.
 - 3.6. The building shall be equipped throughout with an automatic sprinkler system installed in accordance with Section 903.3.1.1.
4. Smokeless propellants not stored according to Item 1, 2, or 3 above shall be stored in a Type 2 or 4 magazine in accordance with Section 3304 and NFPA 495.

SECTION 308 INSTITUTIONAL GROUP I

308.1 Institutional Group I. Institutional Group I occupancy includes, among others, the use of a building or structure, or a portion thereof, in which people are cared for or live in a supervised environment, having physical limitations because of health or age are harbored for medical treatment or other care or treatment, or in which people are detained for penal or correctional purposes or in which the liberty of the occupants is restricted. Institutional occupancies shall be classified as Group I-1, I-2, I-3 or I-4.

308.2 Group I-1. This occupancy shall include buildings, structures or parts thereof housing more than 16 persons, on a 24-hour basis, who because of age, mental disability or other reasons, live in a supervised residential environment that provides personal care services. The occupants are capable of responding to an emergency situation without physical assistance from staff. This group shall include, but not be limited to, the following:

- Alcohol and drug centers
- Assisted living facilities
- Congregate care facilities
- Group homes
- Halfway houses
- Residential board and care facilities
- Social rehabilitation facilities

Exception: In Group I-1 occupancies, not more than five of the residents may require physical assistance from staff to respond to an emergency situation when all residents that may require the physical assistance reside on a single level of exit discharge.

A facility such as the above with five or fewer persons shall be classified as a Group R-3 or shall comply with the *International Residential Code* in accordance with Section 101.2. A facility such as above, housing at least six and not more than 16 persons, shall be classified as Group R-4.

308.3 Group I-2. This occupancy shall include buildings and structures used for medical, surgical, psychiatric, nursing or custodial care for persons who are not capable of self-preservation. This group shall include, but not be limited to, the following:

- Child care facilities
- Convalescent facilities
- Detoxification facilities
- Hospice facilities
- Hospitals
- Mental hospitals
- Nursing homes

Exception: Hospice facilities occupied by 16 or less occupants, excluding staff, are permitted to be classified as Group R-4.

308.3.1 Definitions. The following words and terms shall, for the purposes of this section and as used elsewhere in this code, have the meanings shown herein.

CHILD CARE FACILITIES. Facilities that provide care on a 24-hour basis to more than five children, 2½ years of age or less.

DETOXIFICATION FACILITIES. Facilities that serve patients who are provided treatment for substance abuse on a 24-hour basis and who are incapable of self-preservation or who are harmful to themselves or others.

HOSPICE FACILITY. An institution, place, or building owned or operated by a hospice provider and licensed by the Virginia Department of Health as a hospice facility to provide room, board, and palliative and supportive medical and other health services to terminally ill

patients and their families, including respite and symptom management, on a 24-hour basis to individuals requiring such care pursuant to the orders of a physician.

HOSPITALS AND MENTAL HOSPITALS. Buildings or portions thereof used on a 24-hour basis for the medical, psychiatric, obstetrical or surgical treatment of inpatients who are incapable of self-preservation.

NURSING HOMES. Nursing homes are long-term care facilities on a 24-hour basis, including both intermediate care facilities and skilled nursing facilities, serving more than five persons and any of the persons are incapable of self-preservation.

308.4 Group I-3. This occupancy shall include buildings and structures that are inhabited by more than five persons who are under restraint or security. An I-3 facility is occupied by persons who are generally incapable of self-preservation due to security measures not under the occupants' control. This group shall include, but not be limited to, the following:

- Correctional centers
- Detention centers
- Jails
- Prerelease centers
- Prisons
- Reformatories

Buildings of Group I-3 shall be classified as one of the occupancy conditions indicated in Sections 308.4.1 through 308.4.5 (see Section 408.1).

308.4.1 Condition 1. This occupancy condition shall include buildings in which free movement is allowed from sleeping areas, and other spaces where access or occupancy is permitted, to the exterior via *means of egress* without restraint. A Condition 1 facility is permitted to be constructed as Group R.

308.4.2 Condition 2. This occupancy condition shall include buildings in which free movement is allowed from sleeping areas and any other occupied smoke compartment to one or more other smoke compartments. Egress to the exterior is impeded by locked *exits*.

308.4.3 Condition 3. This occupancy condition shall include buildings in which free movement is allowed within individual smoke compartments, such as within a residential unit comprised of individual *sleeping units* and group activity spaces, where egress is impeded by remote-controlled release of *means of egress* from such a smoke compartment to another smoke compartment.

308.4.4 Condition 4. This occupancy condition shall include buildings in which free movement is restricted from an occupied space. Remote-controlled release is provided to permit movement from *sleeping units*, activity spaces and other occupied areas within the smoke compartment to other smoke compartments.

308.4.5 Condition 5. This occupancy condition shall include buildings in which free movement is restricted from an occupied space. Staff-controlled manual release is provided to permit movement from *sleeping units*, activity

USE AND OCCUPANCY CLASSIFICATION

spaces and other occupied areas within the smoke compartment to other smoke compartments.

308.5 Group I-4, day care facilities. This group shall include buildings and structures occupied by persons of any age who receive custodial care for less than 24 hours by individuals other than parents or guardians, relatives by blood, marriage or adoption, and in a place other than the home of the person cared for. A facility such as the above with five or fewer persons shall be classified as a Group R-3 or shall comply with the *International Residential Code* in accordance with Section 101.2. Places of worship during religious functions are not included.

308.5.1 Adult care facility. A facility that provides accommodations for less than 24 hours for more than five unrelated adults and provides supervision and *personal care services* shall be classified as Group I-4.

Exception: A facility where occupants are capable of responding to an emergency situation without physical assistance from the staff shall be classified as Group R-3.

308.5.2 Child care facility. A facility other than family day homes under Section 310.4 that provides supervision and personal care on less than a 24-hour basis for more than five children 2½ years of age or less shall be classified as Group I-4.

Exception: A child day care facility that provides care for more than five but no more than 100 children 2½ years or less of age, where the rooms in which the children are cared for are located on a level of exit discharge serving such rooms and each of these child care rooms has an exit door directly to the exterior, shall be classified as Group E.

SECTION 309 MERCANTILE GROUP M

309.1 Mercantile Group M. Mercantile Group M occupancy includes, among others, the use of a building or structure or a portion thereof, for the display and sale of merchandise and involves stocks of goods, wares or merchandise incidental to such purposes and accessible to the public. Mercantile occupancies shall include, but not be limited to, the following:

- Department stores
- Drug stores
- Markets
- Motor fuel-dispensing facilities
- Retail or wholesale stores
- Sales rooms

309.2 Quantity of hazardous materials. The aggregate quantity of nonflammable solid and nonflammable or noncombustible liquid hazardous materials stored or displayed in a single *control area* of a Group M occupancy shall not exceed the quantities in Table 414.2.5(1).

SECTION 310 RESIDENTIAL GROUP R

310.1 Residential Group R. Residential Group R includes, among others, the use of a building or structure, or a portion

thereof, for sleeping purposes when not classified as an Institutional Group I or when not regulated by the *International Residential Code* in accordance with Section 101.2. Residential occupancies shall include the following:

R-1 Residential occupancies containing sleeping units where the occupants are primarily transient in nature, including:

- Boarding houses* (transient)
- Hotels (transient)
- Motels (transient)

Congregate living facilities (transient) with 10 or fewer occupants are permitted to comply with the construction requirements for Group R-3.

Exceptions:

1. Nonproprietor occupied bed and breakfast and other transient boarding facilities not more than three stories above grade plane in height with a maximum of 10 occupants total are permitted to be classified as either Group R-3 or Group R-5 provided that smoke alarms are installed in compliance with Section 907.2.10.1.2 for Group R-3 or Section 313.1 of the *International Residential Code* for Group R-5.
2. Proprietor occupied bed and breakfast and other transient boarding facilities not more than three stories above grade plane in height, that are also occupied as the residence of the proprietor, with a maximum of five guest room sleeping units provided for the transient occupants are permitted to be classified as either Group R-3 or R-5 provided that smoke alarms are installed in compliance with Section 907.2.10.1.2 for Group R-3 or Section 313.1 of the *International Residential Code* for Group R-5.

R-2 Residential occupancies containing *sleeping units* or more than two *dwelling units* where the occupants are primarily permanent in nature, including:

- Apartment houses
- Boarding houses* (nontransient)
- Convents
- Dormitories
- Fraternities and sororities
- Hotels (nontransient)
- Live/work units
- Monasteries
- Motels (nontransient)
- Vacation timeshare properties

Congregate living facilities with 16 or fewer occupants are permitted to comply with the construction requirements for Group R-3.

R-3 Residential occupancies where the occupants are primarily permanent in nature and not classified as Group R-1, R-2, R-4 or I, including:

- Buildings that do not contain more than two *dwelling units*.
- Adult care facilities that provide accommodations for five or fewer persons of any age for less than 24 hours.
- Child care facilities that provide accommodations for five or fewer persons of any age for less than 24 hours.
- Congregate living facilities* with 16 or fewer persons.

Adult care and child care facilities that are within a single-family home are permitted to comply with the *International Residential Code*.

R-4 Residential occupancies shall include buildings arranged for occupancy as residential care/assisted living facilities including more than five but not more than 16 occupants, excluding staff and buildings arranged for occupancy as hospice facilities with not more than 16 occupants, excluding staff.

Group R-4 occupancies shall meet the requirements for construction as defined for Group R-3, except as otherwise provided for in this code, or shall comply with the IRC provided the building is protected by an automatic sprinkler system installed in accordance with Section 903.2.7.

Exceptions:

1. Group homes licensed by the Virginia Department of Behavioral Health and Developmental Services that house no more than eight persons with one or more resident counselors shall be classified as Group R-2, R-3, R-4 or R-5. Not more than five of the persons may require physical assistance from staff to respond to an emergency situation.
2. In Group R-4 occupancies, not more than five of the residents may require physical assistance from staff to respond to an emergency situation when all residents that may require the physical assistance from staff reside on a single level of exit discharge of exit discharge and other than using a ramp, a change of elevation using steps or stairs is not within the path of egress to an exit door.
3. Assisted living facilities licensed by the Virginia Department of Social Services that house no more than eight persons, with one or more resident counselors, and all of the residents are capable of responding to an emergency situation without physical assistance from staff, may be classified as Group R-2, R-3 or R-5.
4. Assisted living facilities licensed by the Virginia Department of Social Services that house no more than eight persons, with one or more resident counselors, may be classified as Group R-5 when in compliance with all of the following:
 - 4.1. The building is protected by an automatic sprinkler system installed in accordance with Section 903.3 or Section P2904 of the IRC.
 - 4.2. Not more than five of the residents may require physical assistance from staff to respond to an emergency situation.
 - 4.3. All residents that may require physical assistance from staff to respond to an emergency situation reside on a single level of exit discharge and other than using a ramp, a change in elevation using steps or stairs is not within the path of egress to an exit door.
5. Hospice facilities with five or fewer occupants are permitted to comply with the IRC provided the building is protected by an automatic sprinkler system in

accordance with IRC Section P2904 or IBC Section 903.3.

R-5 Residential occupancies in detached one- and two-family dwellings, townhouses and accessory structures within the scope of the *International Residential Code*, also referred to as the "IRC."

310.2 Definitions. The following words and terms shall, for the purposes of this section and as used elsewhere in this code, have the meanings shown herein.

BOARDING HOUSE. A building arranged or used for lodging for compensation, with or without meals, and not occupied as a single-family unit.

CONGREGATE LIVING FACILITIES. A building or part thereof that contains sleeping units where residents share bathroom and/or kitchen facilities.

DORMITORY. A space in a building where group sleeping accommodations are provided in one room, or in a series of closely associated rooms, for persons not members of the same family group, under joint occupancy and single management, as in college dormitories or fraternity houses.

PERSONAL CARE SERVICE. The care of residents who do not require chronic or convalescent medical or nursing care. Personal care involves responsibility for the safety of the resident while inside the building.

RESIDENTIAL CARE/ASSISTED LIVING FACILITIES. Any congregate residential setting that provides or coordinates personal and health care services, 24-hour supervision and assistance for the maintenance or care of four or more adults who are aged, infirm or disabled and who are cared for in a primarily residential setting, and provides for the protection, general supervision and oversight of the physical and mental well-being of aged, infirmed or disabled individuals. Residents are capable of self-evacuation.

TRANSIENT. Occupancy of a *dwelling unit* or *sleeping unit* for not more than 30 days.

310.3 Group R-5. The construction of Group R-5 structures shall comply with the IRC. The amendments to the IRC set out in Section 310.6 shall be made to the IRC for its use as part of this code. In addition, all references to Section 101.2 in the IBC relating to the construction of such structures subject to the IRC shall be considered to be references to this section.

310.3.1 Additional requirements. Methods of construction, materials, systems, equipment or components for Group R-5 structures not addressed by prescriptive or performance provisions of the IRC shall comply with applicable IBC requirements.

310.4 Family day homes. Family day homes where program oversight is provided by the Virginia Department of Social Services shall be classified as Group R-2, R-3 or R-5.

Note: Family day homes may generally care for up to 12 children. See the DHCD Related Laws Package for additional information.

310.5 Radon-resistant construction in Group R-3 and R-4 structures. Group R-3 and R-4 structures shall be subject to the radon-resistant construction requirements in Appendix F in

localities enforcing such requirements pursuant to Section R325 of the IRC.

310.6 Amendments to the IRC. The following changes shall be made to the IRC for its use as part of this code:

1. Change Section R301.2.1 to read:

R301.2.1 Wind limitations. Buildings and portions thereof shall be limited by wind speed, as defined in Table R301.2(1), and construction methods in accordance with this code. Basic wind speeds shall be determined from Figure R301.2(4). Where different construction methods and structural materials are used for various portions of a building, the applicable requirements of this section for each portion shall apply. Where loads for wall coverings, curtain walls, roof coverings, exterior windows, skylights, garage doors and exterior doors are not otherwise specified, the loads listed in Table R301.2(2) adjusted for height and exposure using Table R301.2(3) shall be used to determine design load performance requirements for wall coverings, curtain walls, roof coverings, exterior windows, skylights, garage doors and exterior doors. Asphalt shingles shall be designed for wind speeds in accordance with Section R905.2.6. Wind speeds for localities in special wind regions, near mountainous terrain, and near gorges shall be based on elevation. Areas at 4,000 feet (1219 200 mm) in elevation or higher shall use 110 V mph (48.4 m/s) and areas under 4,000 feet (1219 200 mm) in elevation shall use 90 V mph (39.6 m/s). Gorge areas shall be based on the highest recorded speed per locality or in accordance with local jurisdiction requirements determined in accordance with Section 6.5.4 of ASCE 7.

2. Change Section R301.2.1.1 to read:

R301.2.1.1 Design criteria. Construction in regions where the basic wind speeds from Figure R301.2(4) equal or exceed 110 miles per hour (49 m/s) shall be designed in accordance with one of the following methods. The elements of design not addressed by those documents in Items 1 through 4 shall be in accordance with this code.

1. American Forest and Paper Association (AF&PA) Wood Frame Construction Manual for One- and Two-Family Dwellings (WFCM); or
2. International Code Council (ICC) Standard for Residential Construction in High Wind Regions (ICC-600); or
3. Minimum Design Loads for Buildings and Other Structures (ASCE-7); or
4. American Iron and Steel Institute (AISI), Standard for Cold-Formed Steel Framing-Prescriptive Method for One- and Two-Family Dwellings (AISI S230).
5. Concrete construction shall be designed in accordance with the provisions of this code.

6. Structural insulated panel (SIP) walls shall be designed in accordance with the provisions of this code.

3. Change Section R301.2.2.1.1 to read:

R301.2.2.1.1 Alternate determination of seismic design category. The Seismic Design Categories and corresponding Short Period Design Spectral Response Accelerations, S_{DS} , shown in Figure R301.2(2) are based on soil Site Class D, as defined in Section 1613.5.2 of the *International Building Code*. If soil conditions are other than Site Class D, the Short Period Design Spectral Response Accelerations, S_{DS} , for a site can be determined according to Section 1613.5 of the *International Building Code*. The value of S_{DS} determined according to Section 1613.5 of the *International Building Code* is permitted to be used to set the seismic design category according to Table R301.2.2.1.1, and to interpolate between values in Tables R602.10.3(3), R603.7 and other seismic design requirements of this code.

4. Delete Section R301.2.2.3 and all subsections.
5. Delete Section R301.2.2.4.
6. Change the exception to Item 1 of Section R301.3 to read:

Exception: For wood framed wall buildings with bracing in accordance with Section R602.10, the wall stud clear height used to determine the maximum permitted story height may be increased to 12 feet (3658 mm) without requiring an engineered design for the building wind and seismic force resisting systems.

7. Add Exception 6 to Section R302.1 to read:
 6. Decks and open porches.
8. Change the last column and add Note "a" to Table R302.1 as shown:

MINIMUM FIRE SEPARATION DISTANCE
< 5 feet ^a
≥ 5 feet ^a
≥ 2 feet to 5 feet ^a
5 feet ^a
< 3 feet
3 feet
5 feet ^a
< 5 feet ^a
5 feet ^a

a. The minimum fire separation distance shall be reduced to 3 feet in developments which are fully sprinklered as provided for in Sections R313.1 or R313.2.

9. Change the exception in Section R302.2 to require a common 2-hour fire-resistance-rated wall instead of a 1-hour fire-resistance-rated wall, unless the townhouse development is fully sprinklered as provided for in Section R313.1, in which case a common 1-hour fire-resistance-rated wall shall be permitted between townhouses.

10. Add the following sentence to the end of Section R302.3 to read:

Dwelling unit separation wall assemblies that are constructed on a lot line shall be constructed as required in Section R302.2 for townhouses.

11. Add an exception to Section R303.8 to read:

Exception: Seasonal structures not used as a primary residence for more than 90 days per year, unless rented, leased or let on terms expressed or implied to furnish heat, shall not be required to comply with this section.

12. Add Section R303.8.1 to read:

R303.8.1 Nonowner occupied required heating. Every dwelling unit or portion thereof which is to be rented, leased or let on terms either expressed or implied to furnish heat to the occupants thereof shall be provided with facilities in accordance with Section R303.8 during the period from October 15 to May 1.

13. Add Section R303.9 to read:

R303.9 Insect screens. Every door, window and other outside opening required for ventilation purposes shall be supplied with approved tightly fitted screens of not less than 16 mesh per inch (16 mesh per 25 mm) and every screen door used for insect control shall have a self-closing device.

14. Add Section R306.5 to read:

R306.5 Water supply sources and sewage disposal systems. The water and drainage system of any building or premises where plumbing fixtures are installed shall be connected to a public or private water supply and a public or private sewer system. As provided for in Section 103.11 for functional design, water supply sources and sewage disposal systems are regulated and approved by the Virginia Department of Health and the Virginia Department of Environmental Quality.

Note: See also the Memorandums of Agreement in the "Related Laws Package," which is available from the Virginia Department of Housing and Community Development.

15. Change Section R310.1 to read:

R310.1 Emergency escape and rescue required. Basements and each sleeping room designated on the construction documents shall have at least one openable emergency escape and rescue opening. Such opening shall be directly to the exterior of the building or to a deck, screen porch or egress court, all of which shall provide access to a public street, public alley or yard. Where emergency escape and rescue openings are provided, they shall have a sill height of not more than 44 inches (1118 mm) above the floor. Where a door opening having a threshold below the adjacent ground elevation serves as an

emergency escape and rescue opening and is provided with a bulkhead enclosure, the bulkhead enclosure shall comply with Section R310.3. The net clear opening dimensions required by this section shall be obtained by the normal operation of the emergency escape and rescue opening from the inside, except that tilt-out or removable sash designed windows shall be permitted to be used. Emergency escape and rescue openings with a finished height below the adjacent ground elevation shall be provided with a window well in accordance with Section R310.2.

Exceptions:

1. Dwelling units equipped throughout with an approved automatic sprinkler system installed in accordance with NFPA 13, 13R, 13D or Section P2904.
2. Basements used only to house mechanical equipment and not exceeding total floor area of 200 square feet (18.58 m²).

16. Change Section R310.1.1 to read:

R310.1.1 Minimum opening area. All emergency escape and rescue openings shall have a minimum net clear opening of 5.7 square feet (0.530 m²), including the tilting or removal of the sash as the normal operation to comply with Sections R310.1.2 and R310.1.3.

Exception: Grade floor openings shall have a minimum net clear opening of 5 square feet (0.465 m²).

17. Change Section R311.7.4.1 to read:

R311.7.4.1 Riser height. The maximum riser height shall be 8¹/₄ inches (210 mm). The riser shall be measured vertically between the leading edges of the adjacent treads. The greatest riser height within any flight of stairs shall not exceed the smallest by more than ³/₈ inch (9.5 mm).

18. Change Section R311.7.4.2 to read:

R311.7.4.2 Tread depth. The minimum tread depth shall be 9 inches (229 mm). The tread depth shall be measured horizontally between the vertical planes of the foremost projection of adjacent treads and at a right angle to the tread's leading edge. The greatest tread depth within any flight of stairs shall not exceed the smallest by more than ³/₈ inch (9.5 mm). Consistently shaped winders at the walkline shall be allowed within the same flight of stairs as rectangular treads and do not have to be within ³/₈ inch (9.5 mm) of the rectangular tread depth. Winder treads shall have a minimum tread depth of 10 inches (254 mm) measured between the vertical planes of the foremost projection of adjacent treads at the intersection with the walkline. Winder treads shall have a minimum tread depth of 6 inches (152 mm) at any point within the clear width of the stair. Within any

flight of stairs, the largest winder tread depth at the walkline shall not exceed the smallest winder tread by more than $\frac{3}{8}$ inch (9.5 mm).

19. Change Section R311.7.6 to read:

R311.7.6 Stairway walking surface. The walking surface of treads and landings of stairways shall be level or sloped no steeper than one unit vertical in 48 inches horizontal (2-percent slope).

20. Replace Section R313 with the following:

**SECTION R313
AUTOMATIC FIRE SPRINKLER SYSTEMS**

R313.1 Townhouse automatic fire sprinkler systems. Notwithstanding the requirements of Section 103.8, where installed, an automatic residential fire sprinkler system for townhouses shall be designed and installed in accordance with NFPA 13D or Section P2904.

Exception: An automatic residential fire sprinkler system shall not be required when additions or alterations are made to existing townhouses that do not have an automatic residential fire sprinkler system installed.

R313.2 One- and two-family dwellings automatic fire sprinkler systems. Notwithstanding the requirements of Section 103.8, where installed, an automatic residential fire sprinkler system shall be designed and installed in accordance with NFPA 13D or Section P2904.

Exception: An automatic residential fire sprinkler system shall not be required for additions or alterations to existing buildings that are not already provided with an automatic residential fire sprinkler system.

21. Change Section R314.2 to read:

R314.2 Smoke detection systems. Household fire alarm systems installed in accordance with NFPA 72 that include smoke alarms, or a combination of smoke detector and audible notification device installed as required by this section for smoke alarms, shall be permitted. The household fire alarm system shall provide the same level of smoke detection and alarm as required by this section for smoke alarms. Where a household fire warning system is installed using a combination of smoke detector and audible notification device(s), the system shall become a permanent fixture of the dwelling unit.

Exception: Where smoke alarms are provided meeting the requirements of Section R314.4.

22. Delete Section R314.3.1.

23. Delete Section R315.2.

24. Change Section R315.3 to read:

R315.3 Alarm requirements. Single station carbon monoxide alarms shall be hard wired, plug-in or

battery type, listed as complying with UL 2034, and shall be installed in accordance with this code and the manufacturer's installation instructions.

25. Add Section R324 Radon-Resistant Construction.

26. Add Section R324.1 to read:

R324.1 Local enforcement of radon requirements. Following official action under Article 7 (Section 15.2-2280 et seq.) of Chapter 22 of Title 15.2 of the Code of Virginia by a locality in areas of high radon potential, as indicated by Zone 1 on the U.S. EPA Map of Radon Zones (IRC Figure AF101), such locality shall enforce the provisions contained in Appendix F.

Exception: Buildings or portions thereof with crawl space foundations which are ventilated to the exterior, shall not be required to provide radon-resistant construction.

27. Add Section R325 Swimming Pools, Spas and Hot Tubs.

28. Add Section R325.1 to read:

R325.1 Use of Appendix G for swimming pools, spas and hot tubs. In addition to other applicable provisions of this code, swimming pools, spas and hot tubs shall comply with the provisions in Appendix G.

29. Add Section R326 Patio Covers.

30. Add Section R326.1 to read:

R326.1 Use of Appendix H for patio covers. Patio covers shall comply with the provisions in Appendix H.

31. Add Section R327 Sound Transmission.

32. Add Section R327.1 to read:

R327.1 Sound transmission between dwelling units. Construction assemblies separating dwelling units shall provide airborne sound insulation as required in Appendix K.

33. Add Section R327.2 to read:

R327.2 Airport noise attenuation. This section applies to the construction of the exterior envelope of detached one- and two-family dwellings and multiple single-family dwellings (townhouses) not more than three stories high with separate means or egress within airport noise zones when enforced by a locality pursuant to Section 15.2-2295 of the Code of Virginia. The exterior envelope of such structures shall comply with Section 1207.4 of the state amendments to the IBC.

34. Add Section R328 Gray Water and Rain Water Recycling Systems.

35. Add Section R328.1 to read:

R328.1 Use of Appendix O for gray water and rain water recycling systems. In addition to other applicable provisions of this code, gray water recy-

cling systems and rain water recycling systems shall comply with the provisions in Appendix O. In the use of Appendix O for rain water recycling systems, the term "rain water" shall be substituted for the term "gray water." Gray water recycling systems and rain water recycling systems shall be separate systems and shall not be interconnected.

36. Add Section R329 Fire Extinguishers.

37. Add Section R329.1 to read:

R329.1 Kitchen areas. Other than where the dwelling is equipped with an approved sprinkler system in accordance with Section R313, a fire extinguisher having a rating of 2-A:10-B:C or an approved equivalent type of fire extinguisher shall be installed in the kitchen area.

38. Change Section R401.3 to read:

R401.3 Drainage. Surface drainage shall be diverted to a storm sewer conveyance or other approved point of collection that does not create a hazard to the dwelling unit. Lots shall be graded to drain surface water away from foundation walls. The grade shall fall a minimum of 6 inches (152 mm) within the first 10 feet (3048 mm).

Exception: Where lot lines, walls, slopes or other physical barriers prohibit 6 inches (152 mm) of fall within 10 feet (3048 mm), drains or swales shall be constructed to ensure drainage away from the structure. Impervious surfaces within 10 feet (3048 mm) of the building foundation shall be sloped a minimum of 2 percent away from the building.

39. Change Section R403.1 to read:

R403.1 General. All exterior walls shall be supported on continuous solid or fully grouted masonry or concrete footings, wood foundations, or other approved structural systems which shall be of sufficient design to accommodate all loads according to Section R301 and to transmit the resulting loads to the soil within the limitations as determined from the character of the soil. Footings shall be supported on undisturbed natural soils or engineered fill.

Exception: One-story detached accessory structures used as tool and storage sheds, playhouses and similar uses, not exceeding 256 square feet (23.7824 m²) of building area, provided all of the following conditions are met:

1. The building eave height is 10 feet (3048 mm) or less.
2. The maximum height from the finished floor level to grade does not exceed 18 inches (457.2 mm).
3. The supporting structural elements in direct contact with the ground shall be placed level on firm soil and when such elements are wood they shall be approved pressure preservative treated suitable for ground contact use.

4. The structure is anchored to withstand wind loads as required by this code.

5. The structure shall be of light-frame construction whose vertical and horizontal structural elements are primarily formed by a system of repetitive wood or light gauge steel framing members, with walls and roof of light weight material, not slate, tile, brick or masonry.

40. Change Exceptions 2 and 3 in Section R403.1.6 to read:

2. Walls 24 inches (610 mm) total length or shorter connecting offset braced wall panels shall be anchored to the foundation with a minimum of one anchor bolt located in the center third of the plate section.

3. Connection of walls 12 inches (305 mm) total length or shorter connecting offset braced wall panels to the foundation without anchor bolts shall be permitted.

41. Delete Item 5 of Section R403.1.6.1.

42. Add Section R408.3.1 to read:

R408.3.1 Termite inspection. Where an unvented crawl space is installed and meets the criteria in Section R408, the vertical face of the sill plate shall be clear and unobstructed and an inspection gap shall be provided below the sill plate along the top of any interior foundation wall covering. The gap shall be a minimum of 1 inch (25.4 mm) and a maximum of 2 inches (50.8 mm) in width and shall extend throughout all parts of any foundation that is enclosed. Joints between the sill plate and the top of any interior wall covering may be sealed.

Exceptions:

1. In areas not subject to damage by termites as indicated by Table R301.2(1).
2. Where other approved means are provided to inspect for potential damage.

Where pier and curtain foundations are installed as depicted in Figure R404.1.5(1), the inside face of the rim joist and sill plate shall be clear and unobstructed except for construction joints which may be sealed.

Exception: Fiberglass or similar insulation may be installed if easily removable.

43. Change Section R502.2.1 to read:

R502.2.1 Framing at braced wall panels. A load path for lateral forces shall be provided between floor framing and braced wall panels located above or below a floor, as specified in Sections R602.3.5 and R602.10.8.

44. Change Section R506.2.1 to read:

R506.2.1 Fill. Fill material shall be free of vegetation and foreign material and shall be natural nonorganic material that is not susceptible to swell-

ing when exposed to moisture. The fill shall be compacted to assure uniform support of the slab, and except where approved, the fill depth shall not exceed 24 inches (610 mm) for clean sand or gravel and 8 inches (203 mm) for earth.

Exception: Material other than natural material may be used as fill material when accompanied by a certification from an RDP and approved by the building official.

45. Change Section R506.2.2 to read:

R506.2.2 Base. A 4-inch-thick (102 mm) base course consisting of clean graded sand, gravel or crushed stone passing a 2-inch (51 mm) sieve shall be placed on the prepared subgrade when the slab is below grade.

Exception: A base course is not required when the concrete slab is installed on well drained or sand-gravel mixture soils classified as Group I according to the United Soil Classification System in accordance with Table R405.1. Material other than natural material may be used as base course material when accompanied by a certification from an RDP and approved by the building official.

46. Modify Table R602.3(1) to change and add items as shown:

7	Built-up studs, face nail	10d (3" × 0.128")	24" o.c.
7a	Abutting studs at intersecting wall corners, face nail	16d (3½" × 0.135")	12" o.c.
26a	Rim joist or blocking to sill plate, toe nail	8d (2½" × 0.113")	6" o.c.

47. Add Section R602.3.5 to read:

R602.3.5 Braced wall panel uplift load path. Braced wall panels located at exterior walls that support roof rafters or trusses (including stories below top story) shall have the framing members connected in accordance with one of the following:

1. Fastening in accordance with Table R602.3(1) where:
 - 1.1. The basic wind speed does not exceed 90 mph (40 m/s), the wind exposure category is B, the roof pitch is 5:12 or greater, and the roof span is 32 feet (9754 mm) or less, or
 - 1.2. The net uplift value at the top of a wall does not exceed 100 plf (146 N/mm). The net uplift value shall be determined in accordance with Section R802.11 and shall be permitted to be reduced by 60 plf (57 N/mm) for each full wall above.

2. Where the net uplift value at the top of a wall exceeds 100 plf (146 N/mm), installing approved uplift framing connectors to provide a continuous load path from the top of the wall to the foundation or to a point where the uplift force is 100 plf (146 N/mm) or less. The net uplift value shall be as determined in Item 1.2 above.
3. Wall sheathing and fasteners designed in accordance with accepted engineering practice to resist combined uplift and shear forces.

48. Change Section R602.9 to read:

R602.9 Cripple walls. Foundation cripple walls shall be framed of studs not smaller than the studing above. When exceeding 4 feet (1219 mm) in height, such walls shall be framed of studs having the size required for an additional story.

Cripple walls with a stud height less than 14 inches (356 mm) shall be continuously sheathed on one side with wood structural panels fastened to both the top and bottom plates in accordance with Table R602.3(1), or the cripple walls shall be constructed of solid blocking. Cripple walls shall be supported on continuous foundations.

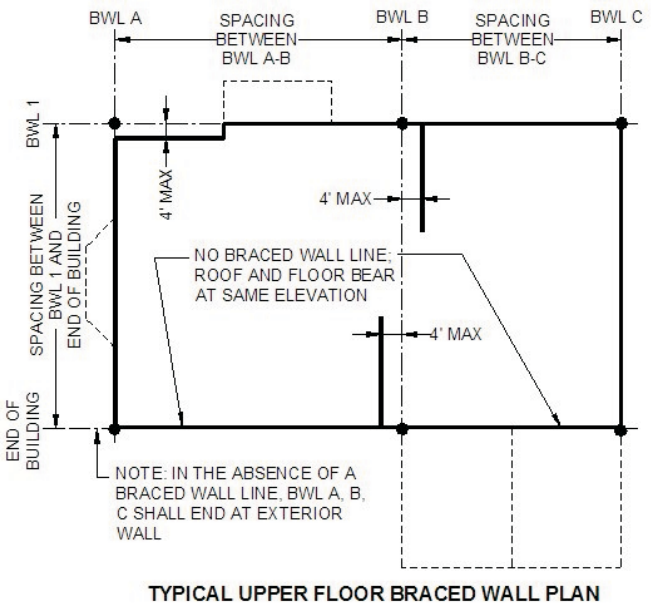
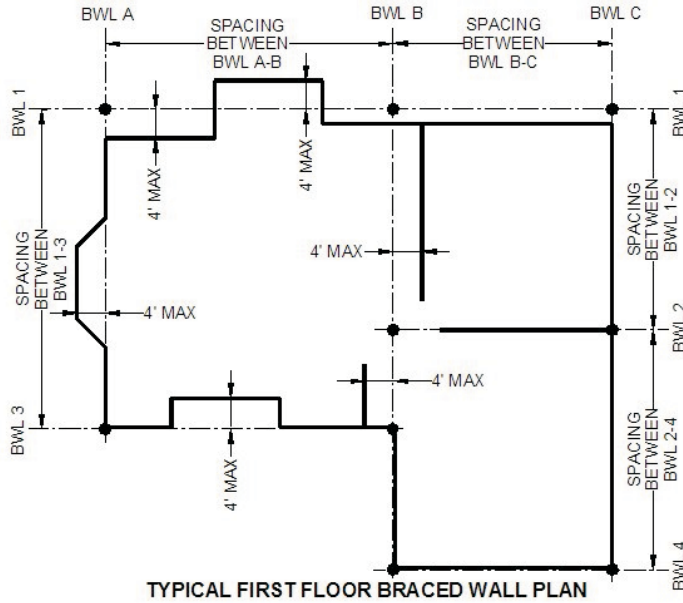
49. Replace Section R602.10, including all subsections, with the following:

R602.10 Wall bracing. Buildings shall be braced in accordance with this section, or, when applicable, Section R602.12. Where a building, or portion thereof, does not comply with one or more of the bracing requirements in this section, those portions shall be designed and constructed in accordance with Section R301.1.

The building official may require the permit applicant to identify and locate on the construction documents braced wall lines and braced wall panels as described herein.

R602.10.1 Braced wall lines. For the purpose of determining the amount and location of bracing required in each story level of a building, braced wall lines shall be designated as straight lines in the building plan placed in accordance with this section.

R602.10.1.1 Length of a braced wall line. The length of a braced wall line shall be the distance between its ends. The end of a braced wall line shall be the intersection with a perpendicular braced wall line, an angled braced wall line as permitted in Section R602.10.1.4 or an exterior wall as shown in Figure R602.10.1.1.



For SI: 1 foot = 304.8 mm.

FIGURE 602.10.1.1 BRACED WALL LINES

R602.10.1.2 Offsets along a braced wall line. All exterior walls parallel to a braced wall line shall be permitted to offset up to 4 feet (1219 mm) from the designated braced wall line location as shown Figure R602.10.1.1. Interior walls used as bracing shall be permitted to offset up to 4 feet (1219 mm) from a braced wall line through the interior of the building as shown in Figure R602.10.1.1.

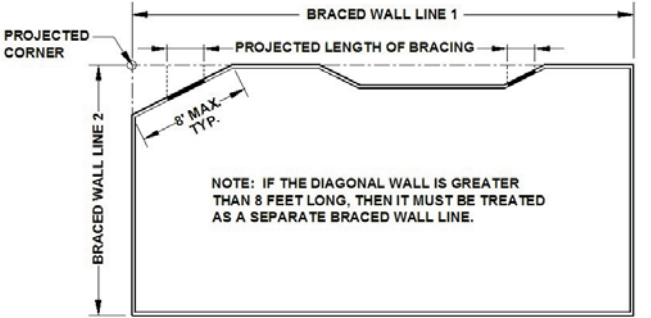
R602.10.1.3 Spacing of braced wall lines. There shall be a minimum of two braced wall lines in both the longitudinal and transverse direction as shown in Figure R602.10.1.1. Intermediate braced wall lines through the interior of the building shall be permitted. The spacing between parallel braced wall lines shall be in accordance with Table R602.10.1.3.

TABLE 602.10.1.3 BRACED WALL LINE SPACING

APPLICATION	CONDITION	BUILDING TYPE	BRACED WALL LINE SPACING CRITERIA	
			Maximum Spacing	Exception to Maximum Spacing
Wind bracing	85 mph to < 110 mph	Detached, townhouse	60 feet	None
Seismic bracing	SDC A – C	Detached	Use wind bracing	
	SDC A – B	Townhouse	Use wind bracing	
	SDC C	Townhouse	35 feet	Up to 50 feet when length of required bracing per Table R602.10.3(3) is adjusted in accordance with Table R602.10.3(4)

For SI: 1 foot = 304.8 mm, 1 mile per hour = 0.44 m/s.

R602.10.1.4 Angled walls. Any portion of a wall along a braced wall line shall be permitted to angle out of plane for a maximum diagonal length of 8 feet (2438 mm). Where the angled wall occurs at a corner, the length of the braced wall line shall be measured from the projected corner as shown in Figure R602.10.1.4. Where the diagonal length is greater than 8 feet (2438 mm), it shall be considered a separate braced wall line and shall be braced in accordance with Section R602.10.1.



For SI: 1 foot = 304.8 mm.

FIGURE 602.10.1.4 ANGLED WALLS

R602.10.2 Braced wall panels. Braced wall panels shall be full-height sections of wall that shall have no vertical or horizontal offsets. Braced wall panels shall be constructed and placed along a braced wall line in accordance with this section and the bracing methods specified in Section R602.10.4.

R602.10.2.1 Braced wall panel uplift load path. The bracing lengths in Table R602.10.3(1) apply only when uplift loads are resisted per Section R602.3.5.

R602.10.2.2 Locations of braced wall panels. A braced wall panel shall begin within 10 feet (3810 mm) from each end of a braced wall line as determined in accordance with Section R602.10.1.1. The distance between adjacent edges of braced wall panels along a braced wall line shall be no greater than 20 feet (6096 mm) as shown in Figure R602.10.2.2.

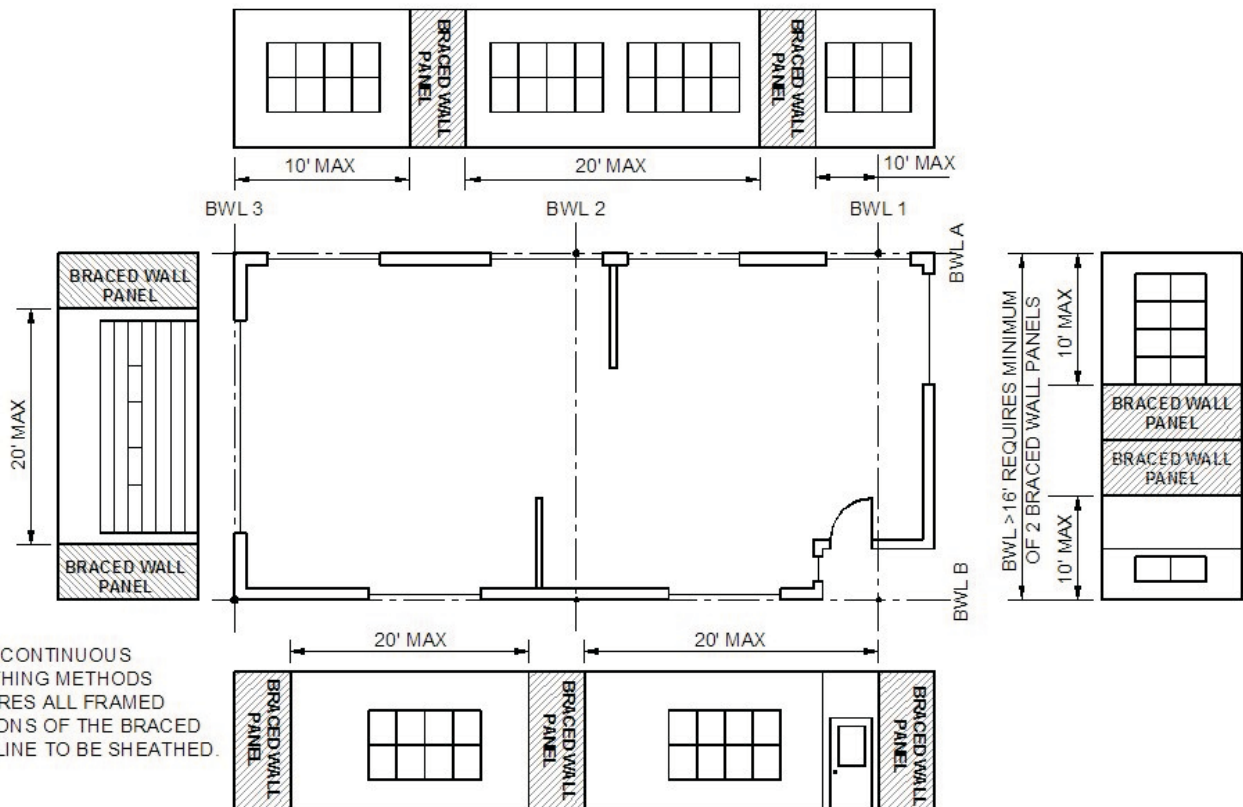
R602.10.2.3 Minimum number of braced wall panels. Braced wall lines with a length of 16 feet (4877 mm) or less shall have a minimum of two braced wall panels of any length or one braced wall panel equal to 48 inches (1219 mm) or more. Braced wall lines greater than 16 feet (4877 mm) shall have a minimum of two braced wall panels.

R602.10.3 Required length of bracing. The required length of bracing along each braced wall line shall be determined as follows.

1. All buildings in Seismic Design Categories A and B shall use Table R602.10.3(1) and the applicable adjustment factors in Table R602.10.3(2).

2. Detached buildings in Seismic Design Category C shall use Table R602.10.3(1) and the applicable adjustment factors in Table R602.10.3(2).
3. Townhouses in Seismic Design Category C shall use the greater value determined from Table R602.10.3(1) or R602.10.3(3) and the applicable adjustment factors in Table R602.10.3(2) or R602.10.3(4) respectively.

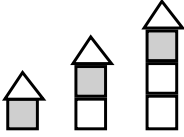
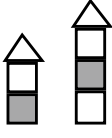

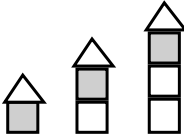
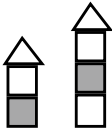

Only braced wall panels parallel to the braced wall line within the 4 foot (1219 mm) offset permitted by Section R602.10.1.2 shall contribute towards the required length of bracing of that braced wall line. If a braced wall panel is located along an angled wall and meets the minimum length requirements of Tables R602.10.5 or R602.10.5.2, it shall be permitted to contribute its projected length towards the minimum required length of bracing for the braced wall line as shown in Figure R602.10.1.4. If a braced wall panel is located along an angled wall at the end of a braced wall line, it shall contribute its projected length for only one of the braced wall lines at the projected corner.



For SI: 1 foot = 304.8 mm.

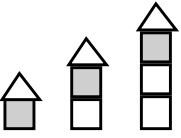
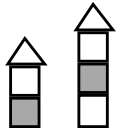

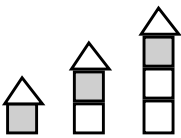
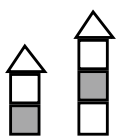

FIGURE 602.10.2.2
LOCATION OF BRACED WALL PANELS

TABLE R602.10.3(1)
BRACING REQUIREMENTS BASED ON WIND SPEED

EXPOSURE CATEGORY B, 30 FT MEAN ROOF HEIGHT, 10 FT EAVE TO RIDGE HEIGHT, 2 BRACED WALL LINES			MINIMUM TOTAL LENGTH (feet) OF BRACED WALL PANELS REQUIRED ALONG EACH BRACED WALL LINE ^a			
Basic Wind Speed (mph)	Story Location	Braced Wall Line Spacing (feet)	Method LIB ^b	Method GB	Methods DWB, WSP, SFB, PBS, PCP, HPS, CS-SFB ^c	Methods CS-WSP, CS-G, CS-PF
≤ 85		10	3.5	3.5	2.0	1.5
		20	6.0	6.0	3.5	3.0
		30	8.5	8.5	5.0	4.5
		40	11.5	11.5	6.5	5.5
		50	14.0	14.0	8.0	7.0
		60	16.5	16.5	9.5	8.0
		10	6.5	6.5	3.5	3.0
		20	11.5	11.5	6.5	5.5
		30	16.5	16.5	9.5	8.0
		40	21.5	21.5	12.5	10.5
		50	26.5	26.5	15.0	13.0
		60	31.5	31.5	18.0	15.5
		10	NP	9.0	5.5	4.5
		20	NP	17.0	10.0	8.5
		30	NP	24.5	14.0	12.0
		40	NP	32.0	18.0	15.5
		50	NP	39.0	22.5	19.0
		60	NP	46.5	26.5	22.5
≤ 90		10	3.5	3.5	2.0	2.0
		20	7.0	7.0	4.0	3.5
		30	9.5	9.5	5.5	5.0
		40	12.5	12.5	7.5	6.0
		50	15.5	15.5	9.0	7.5
		60	18.5	18.5	10.5	9.0
		10	7.0	7.0	4.0	3.5
		20	13.0	13.0	7.5	6.5
		30	18.5	18.5	10.5	9.0
		40	24.0	24.0	14.0	12.0
		50	29.5	29.5	17.0	14.5
		60	35.0	35.0	20.0	17.0
		10	NP	10.5	6.0	5.0
		20	NP	19.0	11.0	9.5
		30	NP	27.5	15.5	13.5
		40	NP	35.5	20.5	17.5
		50	NP	44.0	25.0	21.5
		60	NP	52.0	30.0	25.5

(continued)

**TABLE R602.10.3(1)—continued
BRACING REQUIREMENTS BASED ON WIND SPEED**

EXPOSURE CATEGORY B, 30 FT MEAN ROOF HEIGHT, 10 FT EAVE TO RIDGE HEIGHT, 2 BRACED WALL LINES			MINIMUM TOTAL LENGTH (feet) OF BRACED WALL PANELS REQUIRED ALONG EACH BRACED WALL LINE ^a			
Basic Wind Speed (mph)	Story Location	Braced Wall Line Spacing (feet)	Method LIB ^b	Method GB	Methods DWB, WSP, SFB, PBS, PCP, HPS, CS-SFB ^c	Methods CS-WSP, CS-G, CS-PF
≤ 100		10	4.5	4.5	2.5	2.5
		20	8.5	8.5	5.0	4.0
		30	12.0	12.0	7.0	6.0
		40	15.5	15.5	9.0	7.5
		50	19.0	19.0	11.0	9.5
		60	22.5	22.5	13.0	11.0
		10	8.5	8.5	5.0	4.5
		20	16.0	16.0	9.0	8.0
		30	23.0	23.0	13.0	11.0
		40	29.5	29.5	17.0	14.5
		50	36.5	36.5	21.0	18.0
		60	43.5	43.5	25.0	21.0
		10	NP	12.5	7.5	6.0
		20	NP	23.5	13.5	11.5
		30	NP	34.0	19.5	16.5
		40	NP	44.0	25.0	21.5
		50	NP	54.0	31.0	26.5
		60	NP	64.0	36.5	31.0
< 100 ^c		10	5.5	3.5	2.0	1.5
		20	10.0	6.0	3.5	3.0
		30	14.5	8.5	5.0	4.5
		40	18.5	11.5	6.5	5.5
		50	23.0	14.0	8.0	7.0
		60	27.5	16.5	9.5	8.0
		10	10.5	10.5	6.0	5.0
		20	19.0	19.0	11.0	9.5
		30	27.5	27.5	16.0	13.5
		40	36.0	36.0	20.5	17.5
		50	44.0	44.0	25.5	21.5
		60	52.5	52.5	30.0	25.5
		10	NP	15.5	9.0	7.5
		20	NP	28.5	16.5	14.0
		30	NP	41.0	23.5	20.0
		40	NP	53.0	30.5	26.0
		50	NP	65.5	37.5	32.0
		60	NP	77.5	44.5	37.5

For SI: 1 inch = 25.4 mm, 1 foot = 305 mm.

a. Linear interpolation shall be permitted.

b. Method LIB shall have gypsum board fastened to at least one side with nails or screws per Table R602.3(1) for exterior sheathing or Table R702.3.5 for interior gypsum board. Spacing of fasteners at panel edges shall not exceed 8 inches (203 mm).

c. Method CS-SFB does not apply where the wind speed is greater than 100 mph.

TABLE R602.10.3(2)
WIND ADJUSTMENT FACTORS TO THE REQUIRED LENGTH OF WALL BRACING

ADJUSTMENT BASED ON:	STORY/ SUPPORTING	CONDITION	ADJUSTMENT FACTOR ^{a,b} [multiply length from Table R602.10.3(1) by this factor]	APPLICABLE METHODS
Exposure category	One story structure	B	1.00	All methods
		C	1.20	
		D	1.50	
	Two-story structure	B	1.00	
		C	1.30	
		D	1.60	
	Three-story structure	B	1.00	
		C	1.40	
		D	1.70	
Roof eave-to-ridge height	Roof only	≤ 5 ft	0.70	
		10 ft	1.00	
		15 ft	1.30	
		20 ft	1.60	
	Roof + 1 floor	≤ 5 ft	0.85	
		10 ft	1.00	
		15 ft	1.15	
		20 ft	1.30	
	Roof + 2 floors	≤ 5 ft	0.90	
		10 ft	1.00	
		15 ft	1.10	
		20 ft	Not permitted	
Wall height adjustment	Any story	8 ft	0.90	
		9 ft	0.95	
		10 ft	1.00	
		11 ft	1.05	
		12 ft	1.10	
Number of braced wall lines (per plan direction) ^c	Any story	2	1.00	
		3	1.30	
		4	1.45	
		≥ 5	1.60	
Additional 800 lb hold-down device	Top story only	Fastened to the end studs of each braced wall panel and to the foundation or framing below	0.80	DWB, WSP, SFB, PBS, PCP, HPS
Interior gypsum board finish (or equivalent)	Any story	Omitted from inside face of braced wall panels	1.40	DWB, WSP, SFB,PBS, PCP, HPS, CS-WSP, CS-G, CS-SFB
Gypsum board fastening	Any story	4 in. o.c. at panel edges, including top and bottom plates, and all horizontal joints blocked	0.7	GB

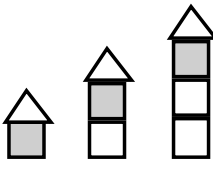
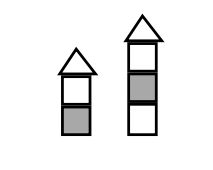
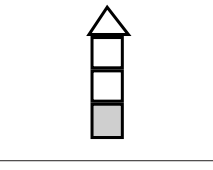
For SI: 1 foot = 305 mm, 1 pound force = 4.48 N.

a. Linear Interpolation shall be permitted.

b. The total adjustment factor is the product of all applicable adjustment factors.

c. The adjustment factor is permitted to be 1.0 when determining bracing amounts of intermediate braced wall lines provided the bracing amounts on adjacent braced wall lines are based on a spacing and number that neglects the intermediate braced wall line.

**TABLE R602.10.3(3)
BRACING REQUIREMENTS BASED ON SEISMIC DESIGN CATEGORY**

SOIL CLASS D ^a WALL HEIGHT = 10 FT 10 PSF FLOOR DEAD LOAD 15 PSF ROOF/CEILING DEAD LOAD BRACED WALL LINE SPACING ≤ 25 FT			MINIMUM TOTAL LENGTH (feet) OF BRACED WALL PANELS REQUIRED ALONG EACH BRACED WALL LINE ^a				
Seismic Design Category (SDC)	Story Location	Braced Wall Line Length (ft)	Method LIB ^c	Method GB	Methods DWB, SFB, PBS, PCP, HPS, CS-SFB	Method WSP	Methods CS-WSP, CS-G
C (townhouses only)		10	2.5	2.5	2.5	1.6	1.4
		20	5.0	5.0	5.0	3.2	2.7
		30	7.5	7.5	7.5	4.8	4.1
		40	10.0	10.0	10.0	6.4	5.4
		50	12.5	12.5	12.5	8.0	6.8
		10	NP	4.5	4.5	3.0	2.6
		20	NP	9.0	9.0	6.0	5.1
		30	NP	13.5	13.5	9.0	7.7
		40	NP	18.0	18.0	12.0	10.2
		50	NP	22.5	22.5	15.0	12.8
		10	NP	6.0	6.0	4.5	3.8
		20	NP	12.0	12.0	9.0	7.7
		30	NP	18.0	18.0	13.5	11.5
		40	NP	24.0	24.0	18.0	15.3
		50	NP	30.0	30.0	30.0	22.5

For SI: 1 foot = 305 mm

- a. Linear interpolation shall be permitted.
- b. Wall bracing lengths are based on a soil site class "D." Interpolation of bracing length between the S_ds values associated with the Seismic Design Categories shall be permitted when a site-specific S_ds value is determined in accordance with Section 1613.5 of the *International Building Code*.
- c. Method LIB shall have gypsum board fastened to at least one side with nails or screws per Table R602.3(1) for exterior sheathing or Table R702.3.5 for interior gypsum board. Spacing of fasteners at panel edges shall not exceed 8 inches (203 mm).

R602.10.4 Bracing methods for braced wall panels. Braced wall panels shall be constructed in accordance with this section and the methods listed in Table R602.10.4.

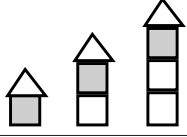
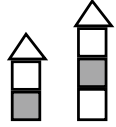

R602.10.4.1 Mixing methods. Mixing of bracing methods shall be permitted as follows:

1. Mixing intermittent bracing and continuous sheathing methods from story to story shall be permitted.
2. Mixing intermittent bracing methods from braced wall line to braced wall line within a story shall be permitted. In regions where the basic wind speed is less than or equal to 100 mph (44 m/s), mixing of intermittent bracing and continuous sheathing methods from braced wall line to braced wall line within a story shall be permitted.
3. Mixing intermittent bracing methods along a braced wall line shall be permitted in Seismic Design Categories A and B, and detached dwellings in Seismic Design Category C provided the length of required bracing in accordance with Table R602.10.3(1) or R602.10.3(3) is the highest value of all intermittent bracing methods used.

dance with Table R602.10.3(1) or R602.10.3(3) is the highest value of all intermittent bracing methods used.

4. Mixing of continuous sheathing methods CS-WSP, CS-G and CS-PF along a braced wall line shall be permitted.
5. In Seismic Design Categories A and B, and for detached one- and two-family dwellings in Seismic Design Category C, mixing of intermittent bracing methods along the interior portion of a braced wall line with continuous sheathing methods CS-WSP, CS-G and CS-PF along the exterior portion of the same braced wall line shall be permitted. The length of required bracing shall be the highest value of all intermittent bracing methods used in accordance with Table R602.10.3(1) or R602.10.3(3) as adjusted by Tables R602.10.3(2) and R602.10.3(4), respectively. The requirements of Section R602.10.7 shall apply to each end of the continuously sheathed portion of the braced wall line.

TABLE R602.10.3(4)
SEISMIC ADJUSTMENT FACTORS TO THE REQUIRED LENGTH OF WALL BRACING

ADJUSTMENT BASED ON:	STORY/SUPPORTING	CONDITION	ADJUSTMENT FACTOR ^{a,b} (multiply length from Table R602.10.3(3) by this factor)	APPLICABLE METHODS
Story height (Section 301.3)	Any story	≤ 10 ft	1.0	All methods
		> 10 ft ≤ 12 ft	1.2	
Braced wall line spacing	Any story	≤ 35 ft	1.0	
		> 35 ft ≤ 50 ft	1.43	
Wall dead load	Any story	> 8 psf < 15 psf	1.0	
		< 8 psf	0.85	
Roof/ceiling dead load for wall supporting	Any story	≤ 15 psf	1.0	
	Roof plus one or two stories	> 15 psf ≤ 25 psf	1.1	
	Roof only	> 15 psf ≤ 25 psf	1.2	
Walls with stone or masonry veneer			1.0	
			1.5	
			1.5	
Interior gypsum board finish (or equivalent)	Any story	Omitted from inside face of braced wall panels	1.5	DWB, WSP, SFB, PBS, PCP, HPS, CS-WSP, CS-G, CS-SFB

For SI: 1 psf = 47.8 N/m.

- a. Linear interpolation shall be permitted.
- b. The total length of bracing required for a given wall line is the product of all applicable adjustment factors.
- c. The length-to-width ratio for the floor/roof diaphragm shall not exceed 3:1. The top plate lap splice nailing shall be a minimum of 12-16d nails on each side of the splice.
- d. Applies to stone or masonry veneer exceeding the first story height.
- e. The adjustment factor for stone or masonry veneer shall be applied to all exterior braced wall lines and all braced wall lines on the interior of the building.

R602.10.4.2 Continuous sheathing methods.

Continuous sheathing methods require structural panel sheathing to be used on all sheathable surfaces on one side of a braced wall line including areas above and below openings and gable end walls and shall meet the requirements of Section R602.10.7.

R602.10.4.3 Braced wall panel interior finish material.

Braced wall panels shall have gypsum wall board installed on the side of the wall opposite the bracing material. Gypsum wall board shall be not less than 1/2 inch (12.7 mm) in thickness and be fastened with nails or screws in accordance with Table R602.3(1) for exterior sheathing or Table R702.3.5 for interior gypsum wall board. Spacing of fasteners at panel edges for gypsum wall board opposite Method LIB bracing shall not exceed 8 inches (203 mm). Interior finish material shall not be glued in townhouses in Seismic Category C.

Exceptions:

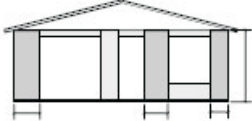
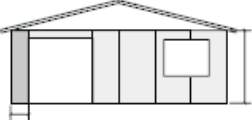
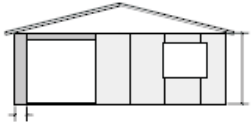
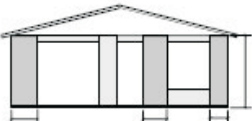
1. Interior finish material is not required opposite wall panels that are braced in accordance with Method GB, ABW, PFH, PFG and CS-PF, unless otherwise required by Section R302.6.
2. An approved interior finish material with an in-plane shear resistance equivalent to gypsum board shall be permitted to be substituted, unless otherwise required by Section R302.6.
3. Except for Method LIB, gypsum wall board is permitted to be omitted provided the required length of bracing in Tables R602.10.3(1) and R602.10.3(3) is multiplied by the appropriate adjustment factor in Tables R602.10.3(2) and R602.10.3(4) respectively, unless otherwise required by Section R302.6.

**TABLE R602.10.4
BRACING METHODS**

METHODS, MATERIAL		MINIMUM THICKNESS	FIGURE	CONNECTION CRITERIAa	
				Fasteners	Spacing
Intermittent Bracing Methods	LIB Let-in-bracing	1×4 wood or approved metal straps at 45° to 60° angles for maximum 16" stud spacing		Wood: 2-8d common nails or 3-8d (2½" long × 0.113" dia.) nails Metal: per manufacturer	Wood: per stud and top and bottom plates Metal: per manufacturer
	DWB Diagonal wood boards	¾" (1" nominal) for maximum 24" stud spacing		2-8d (2½" long × 0.113" dia.) nails or 2 - 1¾" long staples	Per stud
	WSP Wood structural panel (See Section R604)	¾"		Exterior sheathing per Table R602.3(3) Interior sheathing per Table R602.3(1) or R602.3(2)	6" edges 12" field Varies by fastener
	SFB Structural fiberboard sheathing	½" or 25/32" for maximum 16" stud spacing		1½" long × 0.12" dia. (for ½" thick sheathing) 1¾" long × 0.12" dia. (for 25/32" thick sheathing) galvanized roofing nails or 8d common (2½" long × 0.131" dia.) nails	3" edges 6" field
	GB Gypsum board	½"		Nails or screws per Table R602.3(1) for exterior locations Nails or screws per Table R702.3.5 for interior locations	For all braced wall panel locations: 7" edges (including top and bottom plates) 7" field
	PBS Particleboard sheathing (See Section R605)	¾" or ½" for maximum 16" stud spacing		For ¾", 6d common (2" long × 0.113" dia.) nails For ½", 8d common (2½" long × 0.131" dia.) nails	3" edges 6" field
	PCP Portland cement plaster	See Section R703.6 for maximum 16" stud spacing		1½" long, 11 gage, 7/16" dia. head nails or 7/8" long, 16 gage staples	6" o.c. on all framing members
	HPS Hardboard panel siding	7/16" for maximum 16" stud spacing		0.092" dia., 0.225" dia. head nails with length to accommodate 1½" penetration into studs	4" edges 8" field
	ABW Alternate braced wall	¾"		See Section R602.10.6.1	See Section R602.10.6.1
	PFH Portal frame with hold-downs	¾"		See Section R602.10.6.2	See Section R602.10.6.2
	PFG Portal frame at garage	7/16"		See Section R602.10.6.3	See Section R602.10.6.3

continued

**TABLE R602.10.4
BRACING METHODS**

METHODS, MATERIAL	MINIMUM THICKNESS	FIGURE	CONNECTION CRITERIA ^a		
			Fasteners	Spacing	
Continuous Sheathing Methods	CS-WSP Continuously sheathed wood structural panel	3/8"		Exterior sheathing per Table R602.3(3)	6" edges 12" field
	CS-G^{b,c} Continuously sheathed wood structural panel adjacent to garage openings	3/8"		See Method CS-WSP	Varies by fastener
	CS-PF Continuously sheathed portal frame	7/16"		See Section R602.10.6.4	See Section R602.10.6.4
	CS-SFB^d Continuously sheathed structural fiberboard	1/2" or 25/32" for maximum 16" stud spacing		1 1/2" long x 0.12" dia. (for 1/2" thick sheathing) 1 3/4" long x 0.12" dia. (for 25/32" thick sheathing) galvanized roofing nails or 8d common (2 1/2" long x 0.131 dia.) nails	3" edges 6" field

For SI: 1 inch = 25.4 mm, 1 foot = 305 mm.

- a. Adhesive attachment of wall sheathing, including Method GB, shall not be permitted in townhouses in Seismic Design Category C.
- b. Applies to panels next to garage door opening when supporting gable end wall or roof load only. May only be used on one wall of the garage.
- c. Garage openings adjacent to a Method CS-G panel shall be provided with a header in accordance with Table R502.5(1). A full height clear opening shall not be permitted adjacent to a Method CS-G panel.
- d. Method CS-SFB does not apply in areas where the wind speed exceeds 100 mph.

R602.10.5 Minimum length of a braced wall panel. The minimum length of a braced wall panel shall comply with Table R602.10.5. For Methods CS-WSP and CS-SFB, the minimum panel length shall be based on the vertical dimension of the adjacent opening in accordance with Table R602.10.5 and Figure R602.10.5. When a panel has openings on either side of differing heights, the larger vertical dimension shall be used to determine the minimum braced wall panel length.

R602.10.5.1 Contributing length. For purposes of complying with the required length of bracing in Tables R602.10.3(1) and R602.10.3(3), the contributing length of each braced wall panel to the total length of bracing shall be as specified in Table R602.10.5.

R602.10.5.2 Partial credit. For Methods DWB, WSP, SFB, PBS, PCP and HPS panels between 36 inches and 48 inches in length shall be considered a braced wall panel and shall be permitted to partially contribute towards the

required length of bracing in Table R602.10.3(1) and R602.10.3(3), and the contributing length shall be determined from Table R602.10.5.2.

**TABLE R602.10.5.2
PARTIAL CREDIT FOR BRACED WALL PANELS
LESS THAN 48 INCHES IN ACTUAL LENGTH**

ACTUAL LENGTH OF BRACED WALL PANEL (in)	CONTRIBUTING LENGTH OF BRACED WALL PANEL (in) ^a	
	8 ft Wall Height	9 ft Wall Height
48	48	48
42	36	36
36	27	N/A

For SI: 1 inch = 25.4 mm, 1 foot = 304.8 mm.

- a. Linear interpolation shall be permitted.

R602.10.6 Construction of Methods ABW, PFH, PFG and CS-PF. Methods ABW, PFH, PFG and CS-PF shall be constructed as specified in Sections R602.10.6.1 through R602.10.6.4.

**TABLE R602.10.5
MINIMUM LENGTH OF BRACED WALL PANELS**

METHOD (See Table R602.10.4)		MINIMUM LENGTH ^a (in)					CONTRIBUTING LENGTH (in)
		Wall Height					
		8 ft	9 ft	10 ft	11 ft	12 ft	
DWG, WSP, SFB, PBS, PCP, HPS		48	48	48	53	58	Actual ^b
GB		48	48	48	53	58	Double sided = Actual Single sided = 0.5 x Actual
LIB		55	62	69	NP	NP	Actual ^b
ABW		28	32	34	38	42	48
PFH	Supporting roof only	16	16	16	18 ^c	20 ^c	48
	Supporting one story and roof	24	24	24	27 ^c	29 ^c	48
PFG		24	27	30	33 ^c	36 ^c	1.5 x Actual ^b
CS-G		24	27	30	33	36	Actual ^b
CS-PF		16	18	20	22 ^c	24 ^c	Actual ^b
CS-WSP, CS-SFB	Adjacent opening vertical dimension (in)						
	≤ 64	24	27	30	33	36	Actual ^b
	68	26	27	30	33	36	
	72	27	27	30	33	36	
	76	30	29	30	33	36	
	80	32	30	30	33	36	
	84	35	32	32	33	36	
	88	38	35	33	33	36	
	92	43	37	35	35	36	
	96	48	41	38	36	36	
	100		44	40	38	38	
	104		49	43	40	39	
	108		54	46	43	41	
	112			50	45	43	
	116			55	48	45	
	120			60	52	48	
	124				56	51	
	128				61	54	
	132				66	58	
	136					62	
140					66		
144					72		

For SI: 1 inch = 25.4 mm, 1 foot = 304.8 mm.

NP = Not permitted

a. Linear interpolation shall be permitted.

b. Use the actual length provided it is greater than or equal to the minimum length.

c. Maximum header height is 10 feet; however, wall height may be increased to 12 feet with a pony wall per Table R602.10.6.4.

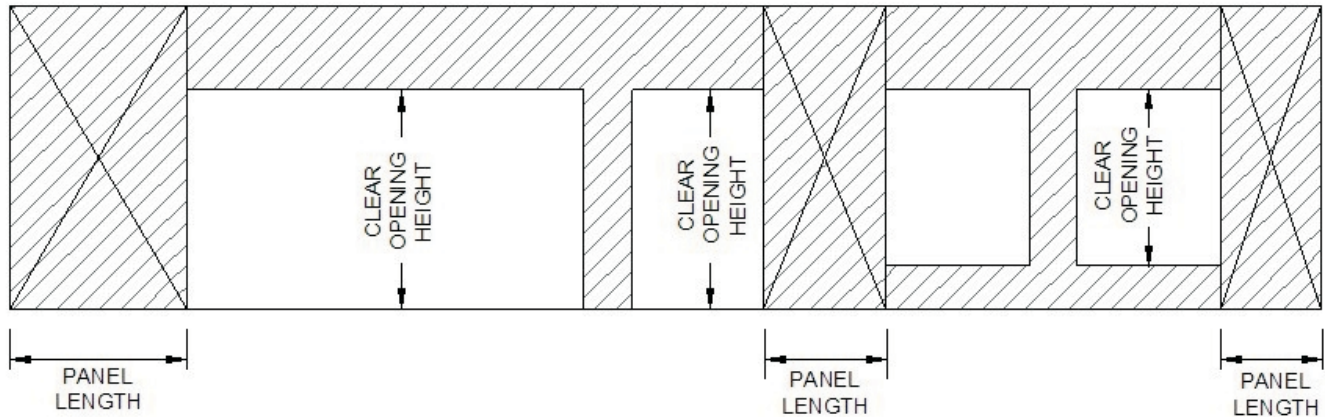


FIGURE R602.10.5
BRACED WALL PANELS WITH CONTINUOUS SHEATHING

R602.10.6.1 Method ABW: Alternate braced wall panels. Method ABW braced wall panels shall be constructed in accordance with Figure R602.10.6.1.

R602.10.6.2 Method PFH: Portal frame with hold-downs. Method PFH braced wall panels shall be constructed in accordance with Figure R602.10.6.2.

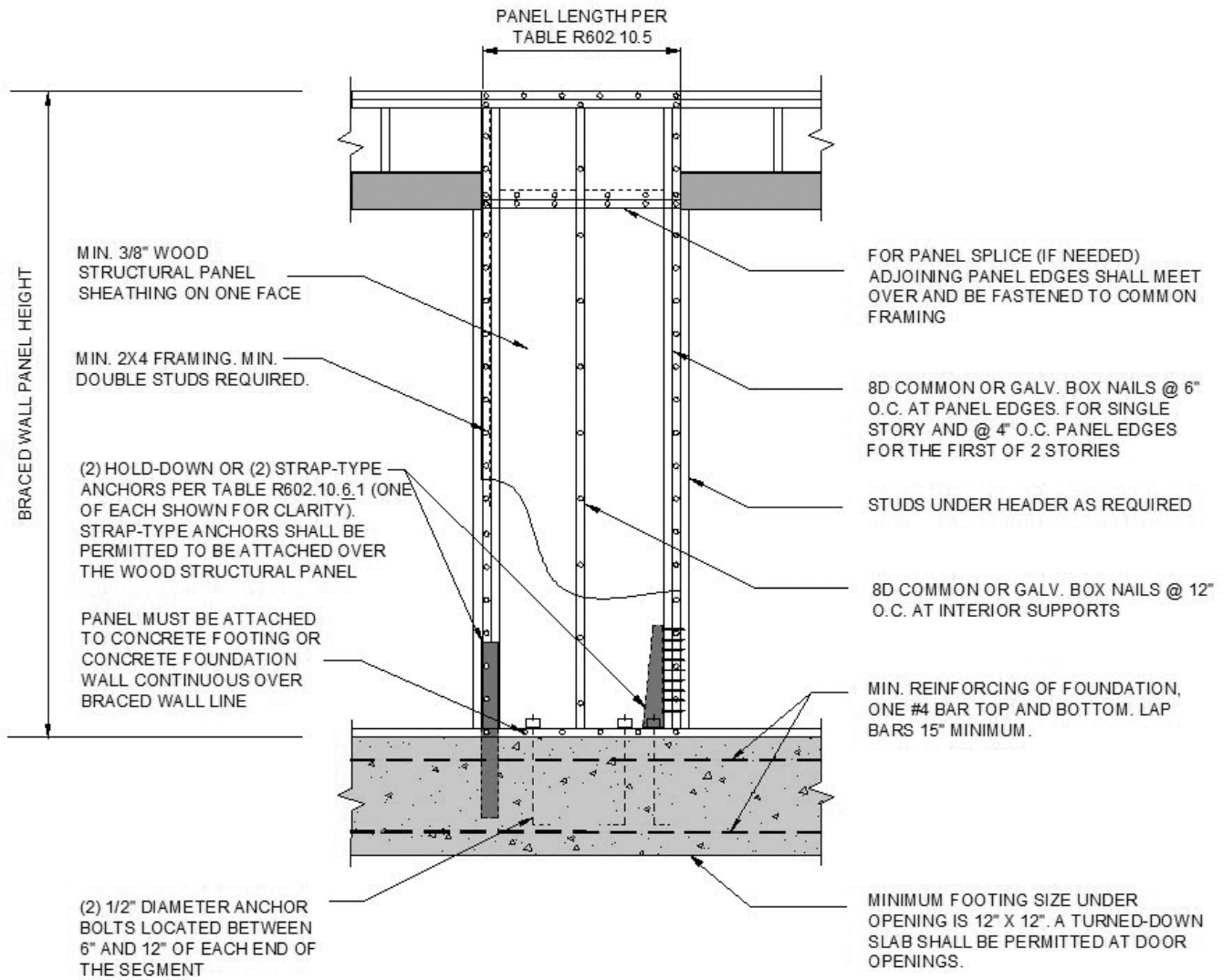
R602.10.6.3 Method PFG: Portal frame at garage door openings. Where supporting a roof or one story and a roof, a Method PFG braced wall panel constructed in accordance with Figure R602.10.6.3 shall be permitted on either side of garage door openings.

R602.10.6.4 Method CS-PF: Continuously sheathed portal frame. Continuously sheathed portal frame braced wall panels shall be constructed in accordance with Figure R602.10.6.4 and Table R602.10.6.4. The number of continuously sheathed portal frame panels in a single braced wall line shall not exceed four.

R602.10.7 Ends of braced wall lines with continuous sheathing. Each end of a braced wall line with continuous sheathing shall be in accordance with one of the end conditions shown in Figure R602.10.7.

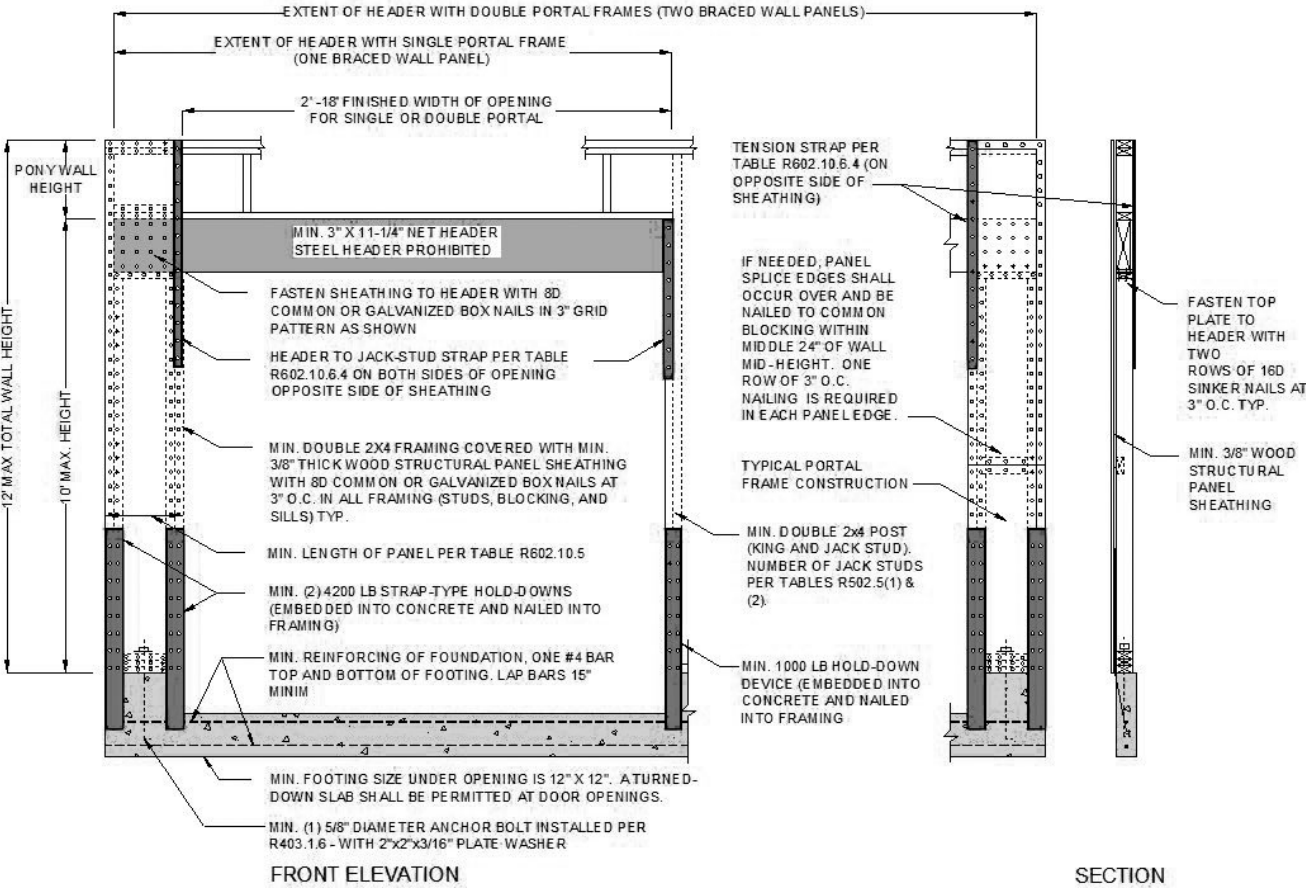
R602.10.8 Braced wall panel connections. Braced wall panels shall be connected to floor framing or foundations as follows:

1. Where joists are perpendicular to a braced wall panel above or below, a rim joist, band joist or blocking shall be provided along the entire length of the braced wall panel in accordance with Figure R602.10.8(1). Fastening of top and bottom wall plates to framing, rim joist, band joist and/or blocking shall be in accordance with Table R602.3(1).
2. Where joists are parallel to a braced wall panel above or below, a rim joist, end joist or other parallel framing member shall be provided directly above and below the braced wall panel in accordance with Figure R602.10.8(2). Where a parallel framing member cannot be located directly above and below the panel, full-depth blocking at 16 inch (406 mm) spacing shall be provided between the parallel framing members to each side of the braced wall panel in accordance with Figure R602.10.8(2). Fastening of blocking and wall plates shall be in accordance with Table R602.3(1) and Figure R602.10.8(2).
3. Connections of braced wall panels to concrete or masonry shall be in accordance with Section R403.1.6.



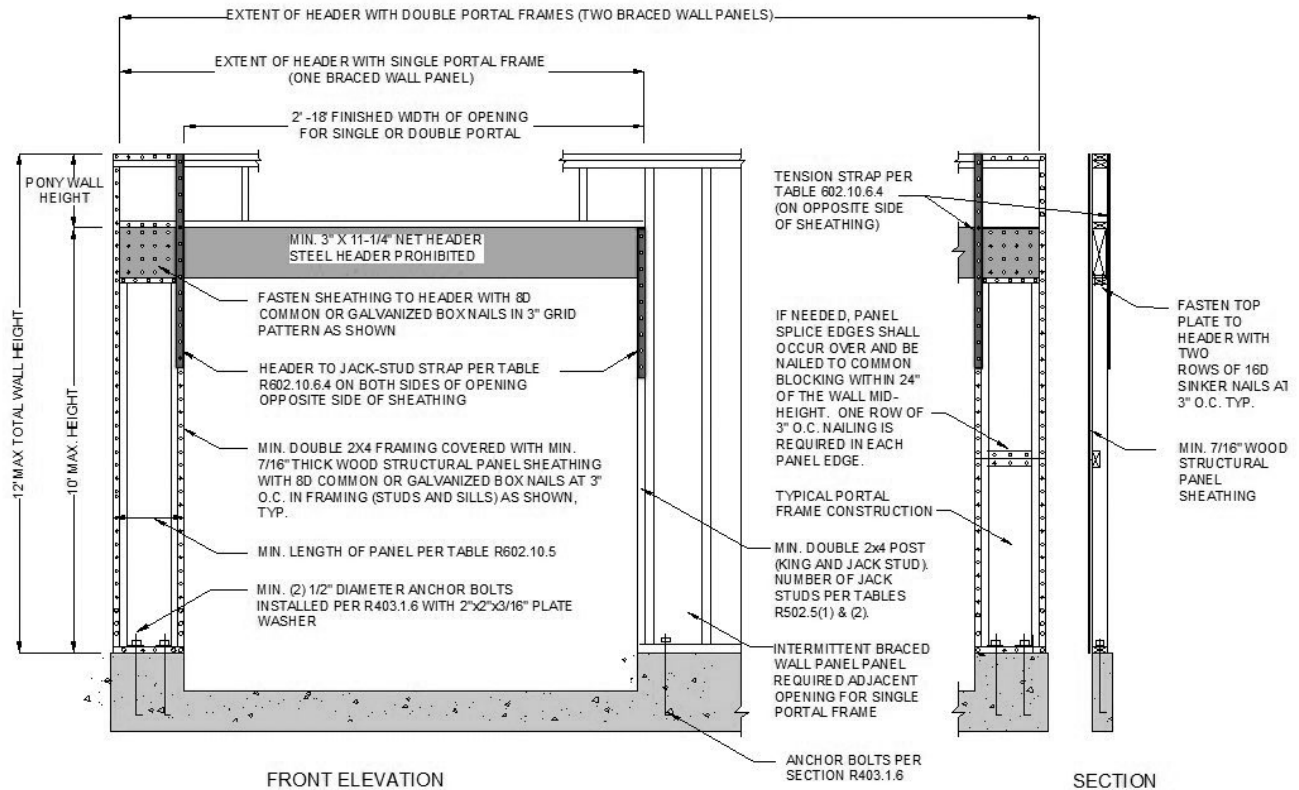
For SI: 1 inch = 25.4 mm, 1 foot = 305 mm.

**FIGURE R602.10.6.1
METHOD ABW: ALTERNATE BRACED WALL PANEL**



For SI: 1 inch = 25.4 mm, 1 foot = 305 mm.

FIGURE R602.10.6.2
METHOD PFH: PORTAL FRAME WITH HOLD-DOWNS



For SI: 1 inch = 25.4 mm, 1 foot = 305 mm.

FIGURE R602.10.6.3
METHOD PFG: PORTAL FRAME AT GARAGE DOOR OPENINGS IN SEISMIC DESIGN CATEGORIES A, B AND C

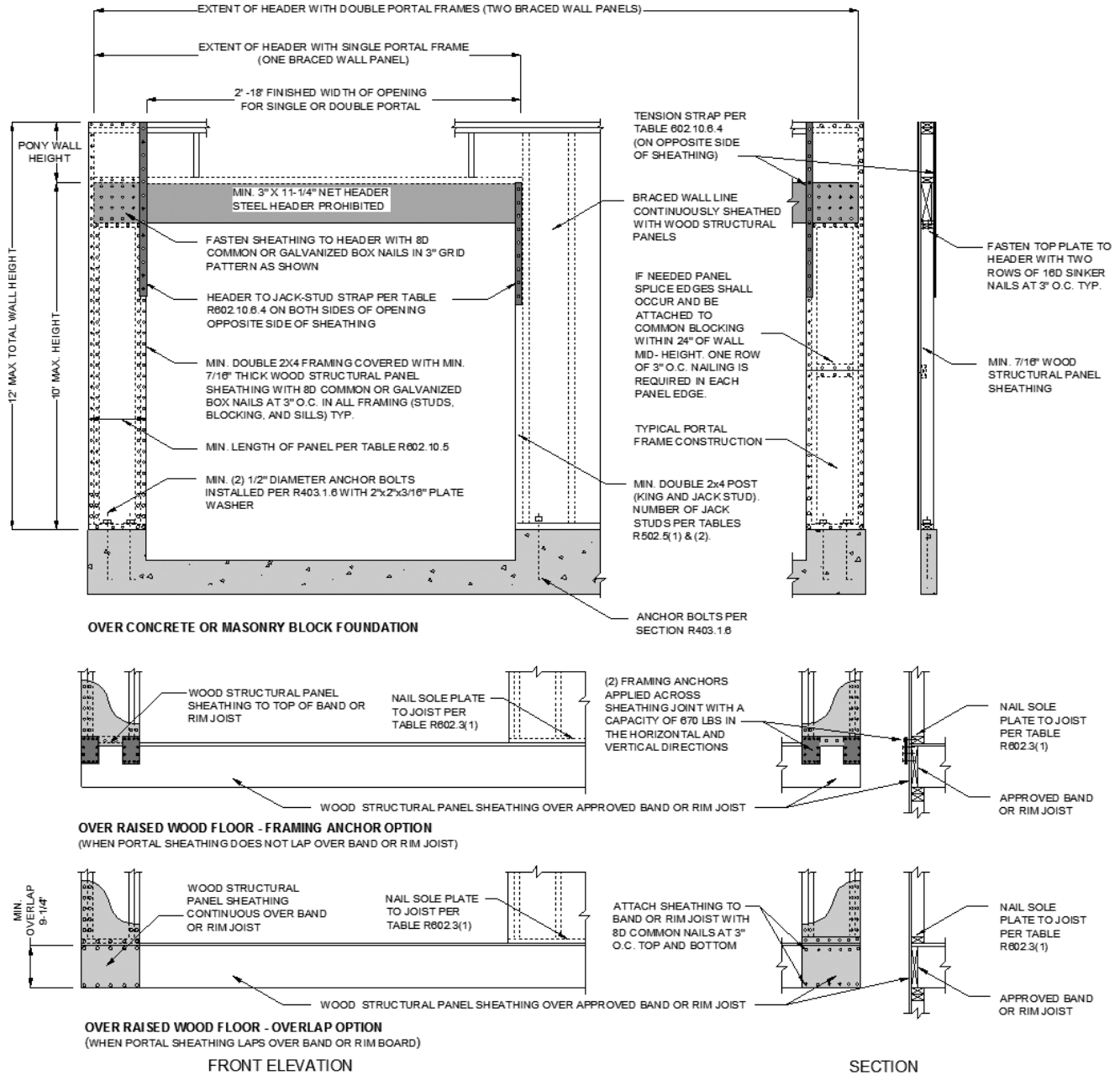
**TABLE R602.10.6.4
TENSION STRAP CAPACITY REQUIRED FOR RESISTING WIND PRESSURES
PERPENDICULAR TO METHOD PFH, PFG AND CS-PF BRACED WALL PANELS**

MINIMUM WALL STUD FRAMING NOMINAL SIZE AND GRADE	MAXIMUM PONY WALL HEIGHT (ft)	MAXIMUM TOTAL WALL HEIGHT (ft)	MAXIMUM OPENING WIDTH (ft)	TENSION STRAP CAPACITY REQUIRED (lb) ^a					
				Basic Wind Speed (mph)					
				85	90	100	85	90	100
				Exposure B			Exposure C		
2x4 No. 2 Grade	0	10	18	1000	1000	1000	1000	1000	1000
	1	10	9	1000	1000	1000	1000	1000	1275
			16	1000	1000	1750	1800	2325	3500
			18	1000	1200	2100	2175	2725	DR
	2	10	9	1000	1000	1025	1075	1550	2500
			16	1525	2025	3125	3200	3900	DR
			18	1875	2400	3575	3700	DR	DR
	2	12	9	1000	1200	2075	2125	2750	4000
			16	2600	3200	DR	DR	DR	DR
			18	3175	3850	DR	DR	DR	DR
	4	12	9	1775	2350	3500	3550	DR	DR
			16	4175	DR	DR	DR	DR	DR
2x6 Stud Grade	2	12	9	1000	1000	1325	1375	1750	2550
			16	1650	2050	2925	3000	3550	DR
			18	2025	2450	3425	3500	4100	DR
	4	12	9	1125	1500	2225	2275	2775	3800
			16	2650	3150	DR	DR	DR	DR
			18	3125	3675	DR	DR	DR	DR

For SI: 1 inch = 25.4 mm, 1 foot = 305 mm, 1 pound force = 4.48 N.

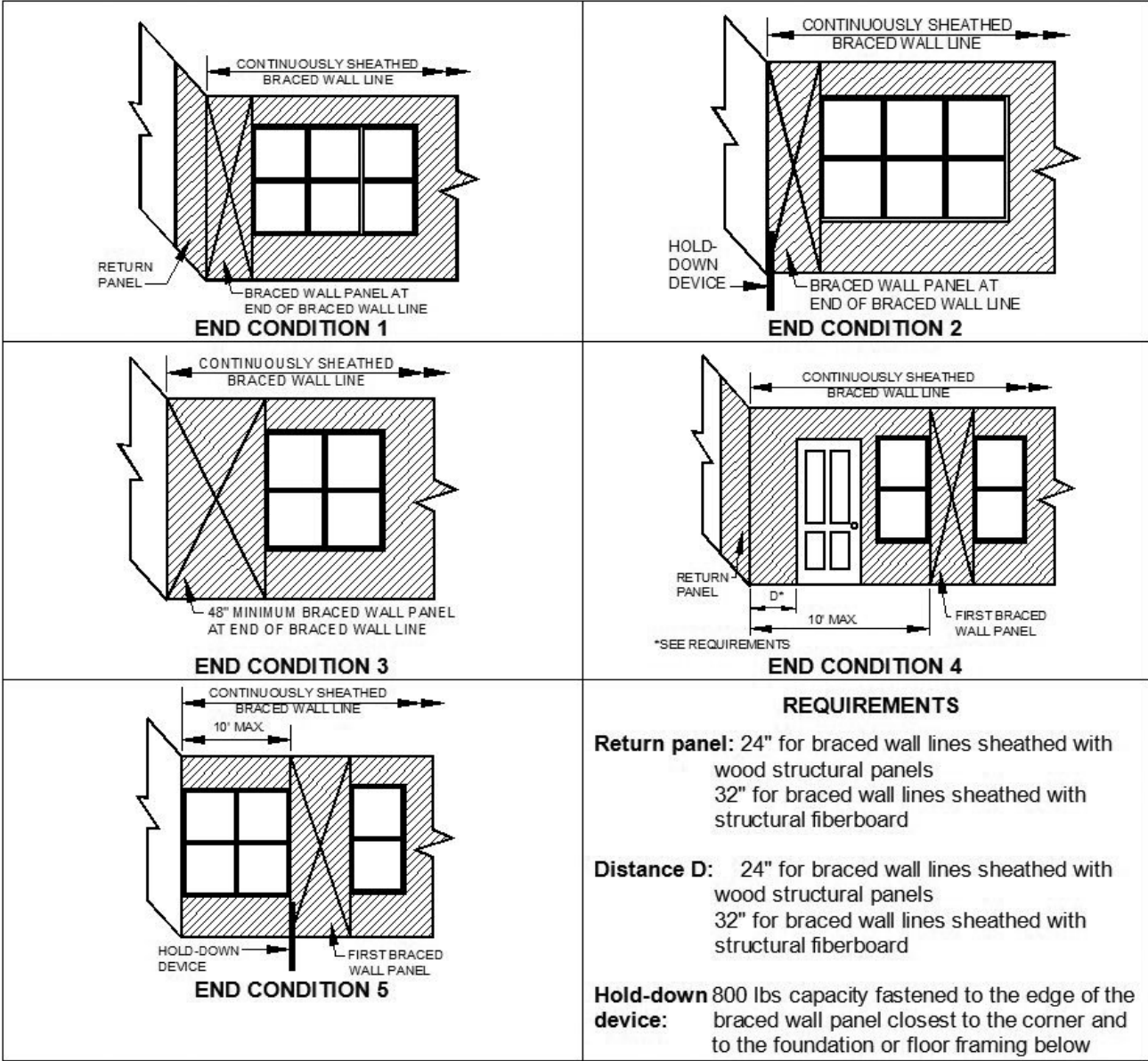
DR = design required

a. Strap shall be installed in accordance with manufacturer’s recommendations.



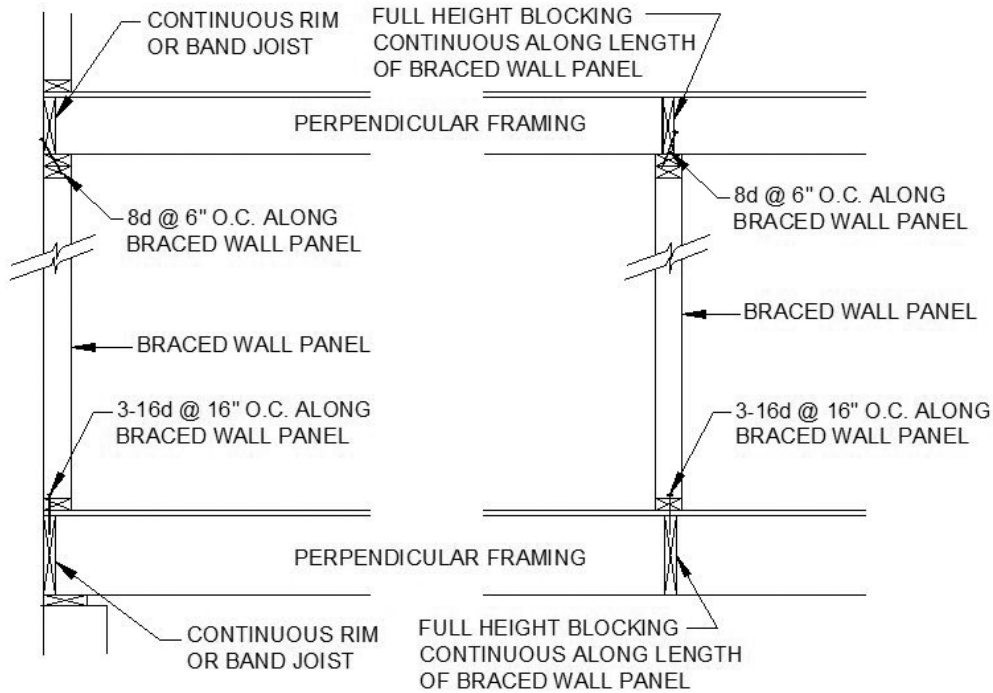
For SI: 1 inch = 25.4 mm, 1 foot = 305 mm, 1 pound force = 4.48 N.

FIGURE R602.10.6.4
METHOD CS-PF: CONTINUOUSLY SHEATHED PORTAL FRAME PANEL CONSTRUCTION



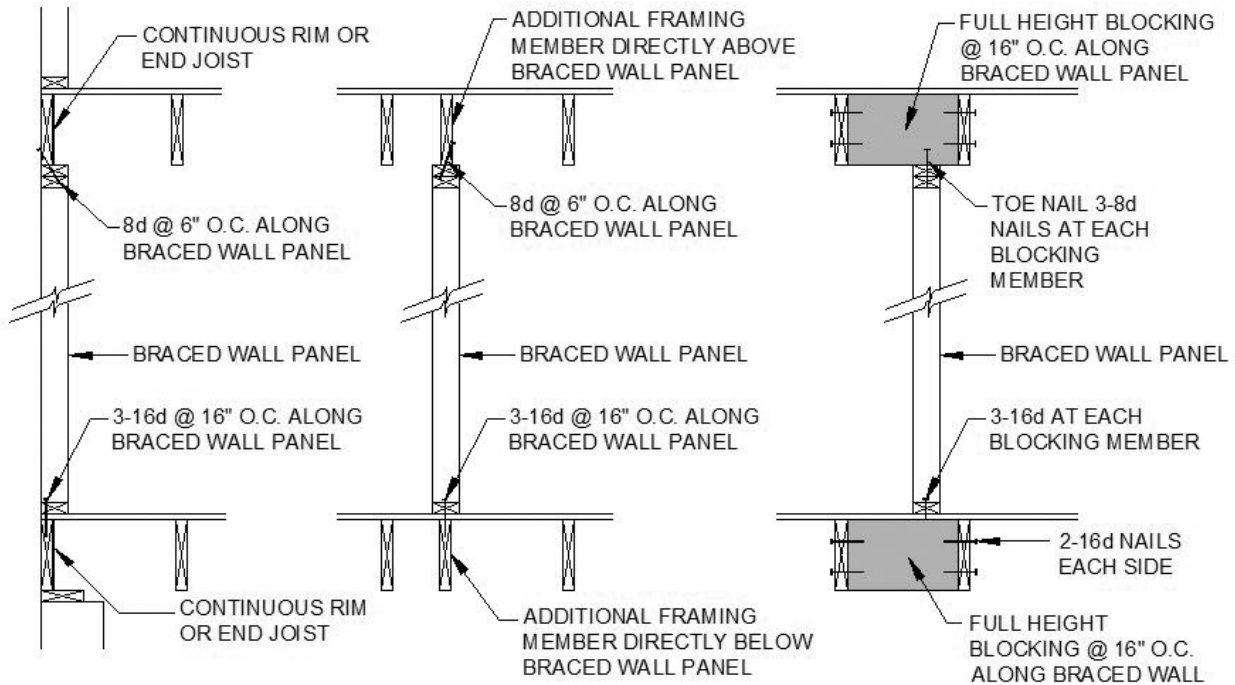
For SI: 1 inch = 25.4 mm, 1 foot = 305 mm, 1 pound force = 4.48 N.

FIGURE R602.10.7
END CONDITIONS FOR BRACED WALL LINES WITH CONTINUOUS SHEATHING



For SI: 1 inch = 25.4 mm.,

FIGURE R602.10.8(1)
BRACED WALL PANEL CONNECTION WHEN PERPENDICULAR TO FLOOR/CEILING FRAMING



For SI: 1 inch = 25.4 mm.,

FIGURE R602.10.8(2)
BRACED WALL PANEL CONNECTION WHEN PARALLEL TO FLOOR/CEILING FRAMING

R602.10.8.1 Connections to roof framing. Top plates of exterior braced wall panels shall be attached to rafters or roof trusses above in accordance with Table R602.3(1) and this section. Where required by this section, blocking between rafters or roof trusses shall be attached to top plates of braced wall panels and to rafters and roof trusses in accordance with Table R602.3(1). A continuous band, rim, or header joist or roof truss parallel to the braced wall panels shall be permitted to replace the blocking required by this section. Blocking shall not be required over openings in continuously sheathed braced wall lines. In addition to the requirements of this section, lateral support shall be provided for rafters and ceiling joists in accordance with Section R802.8 and for trusses in accordance with Section R802.10.3. Roof ventilation shall be provided in accordance with Section R806.1.

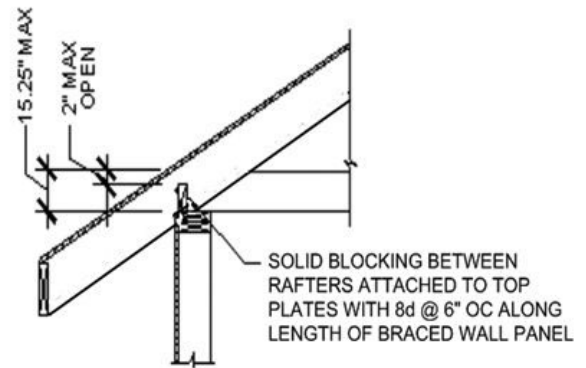
1. For wind speeds less than 100 mph (45 m/s):

1.1. Where the distance from the top of the braced wall panel to the top of the rafters or roof trusses above is 9.25 inches (235 mm) or less, blocking between rafters or roof trusses shall not be required.

1.2. Where the distance from the top of the braced wall panel to the top of the rafters or roof trusses above is between 9.25 inches (235 mm) and 15.25 inches (387 mm) blocking between rafters or roof trusses shall be provided above the braced wall panel in accordance with Figure R602.10.8.1(1).

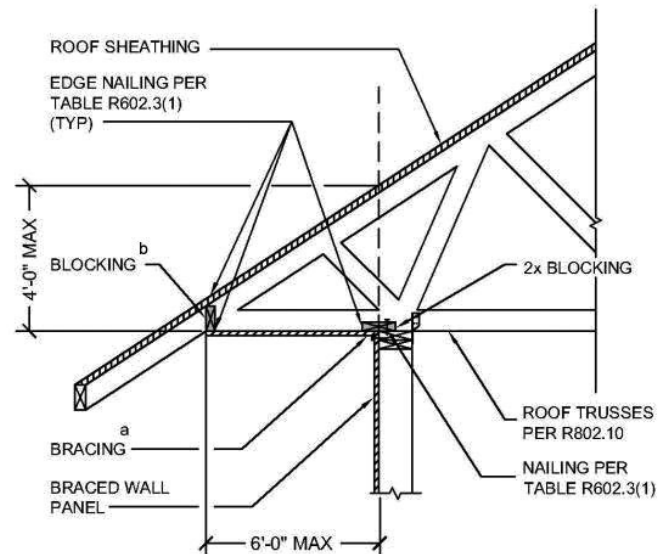
2. For wind speeds of 100 mph (45 m/s) or greater, where the distance from the top of the braced wall panel to the top of the rafters or roof trusses is 15.25 inches (387 mm) or less, blocking between rafters or roof trusses shall be provided above the braced wall panel in accordance with Figure R602.10.8.1(1).

3. Where the distance from the top of the braced wall panel to the top of the rafters or roof trusses exceeds 15.25 inches (387 mm), the top plate of the braced wall panel shall be connected to perpendicular rafters or roof trusses above in accordance with one or more of the following methods:



For SI: 1 inch = 25.4 mm.

**FIGURE R602.10.8.1(1)
BRACED WALL PANEL CONNECTION
TO PERPENDICULAR RAFTERS**



For SI: 1 inch = 25.4 mm.

- a. Methods of bracing shall be as described in Section R602.10.4
- b. Provide ventilation (not shown) per Section R806.

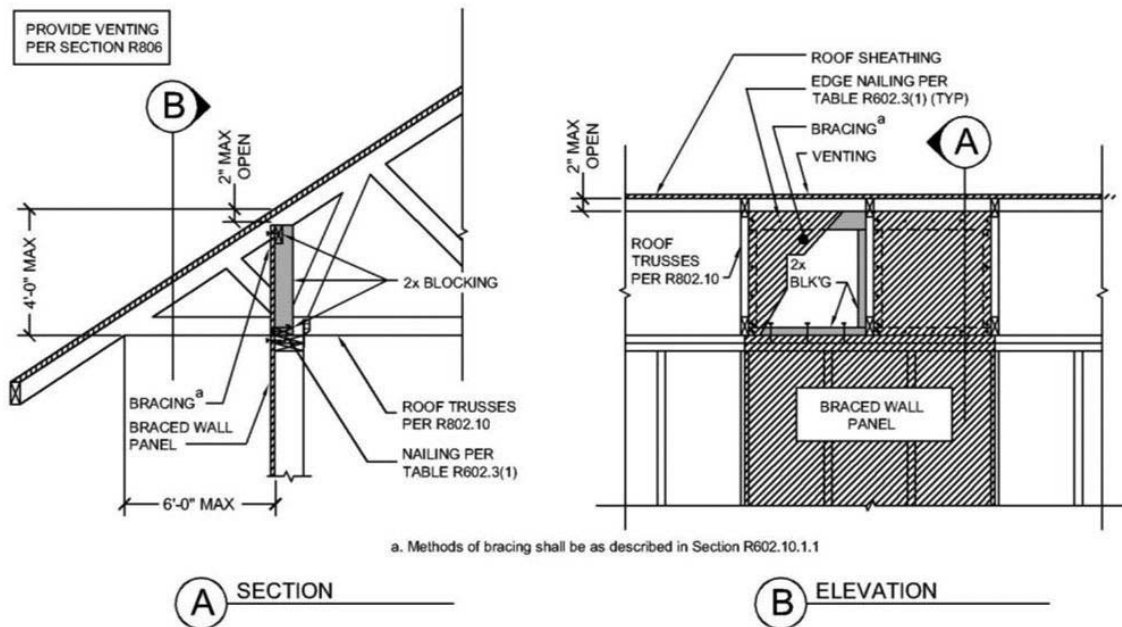
**FIGURE R602.10.8.1(2)
BRACED WALL PANEL CONNECTION OPTION TO
PERPENDICULAR RAFTERS OR ROOF TRUSSES**

3.1. Soffit blocking panels constructed per Figure R602.10.8.1(2).

3.2. Vertical blocking panels constructed per Figure R602.10.8.1(3).

3.3. Full-height engineered blocking panels designed per the AF&PA WFCM.

3.4. Blocking, blocking panels, or other methods of lateral load transfer designed in accordance with accepted engineering practice.



a. Methods of bracing shall be as described in Section R602.10.1.1

FIGURE R602.10.8.1(3)
BRACED WALL PANEL CONNECTION OPTION TO PERPENDICULAR RAFTERS OR ROOF TRUSSES

R602.10.9 Braced wall panel support. Braced wall panel support shall be provided as follows:

1. Cantilevered floor joists complying with Section R502.3.3 shall be permitted to support braced wall panels.
2. Elevated post or pier foundations supporting braced wall panels shall be designed in accordance with accepted engineering practice.
3. Masonry stem walls less than 48 inches (1220 mm) in length that support braced wall panels shall be reinforced in accordance with Figure R602.10.9.

Masonry stem walls with a length greater than or equal to 48 inches (1220 mm) supporting braced wall panels shall be constructed in accordance with Section R403.1. Methods ABW and PFH shall not be permitted to attach to masonry stem walls.

4. Concrete stem walls less than 48 inches (1220 mm) in length, greater than 12 inches (305 mm) tall and less than 6 inches (152 mm) thick shall have reinforcement sized and located in accordance with Figure R602.10.9.

Exception: As an alternative to the Optional Stem Wall Reinforcement in Figure R602.10.9, an approved post-installed adhesive

anchoring system shall be permitted. A minimum of two anchors shall be installed as indicated in Figure R602.10.9. Anchors shall be located not more than 4 inches (102 mm) from each end of the stem wall. Anchors shall be installed into the concrete footing as follows:

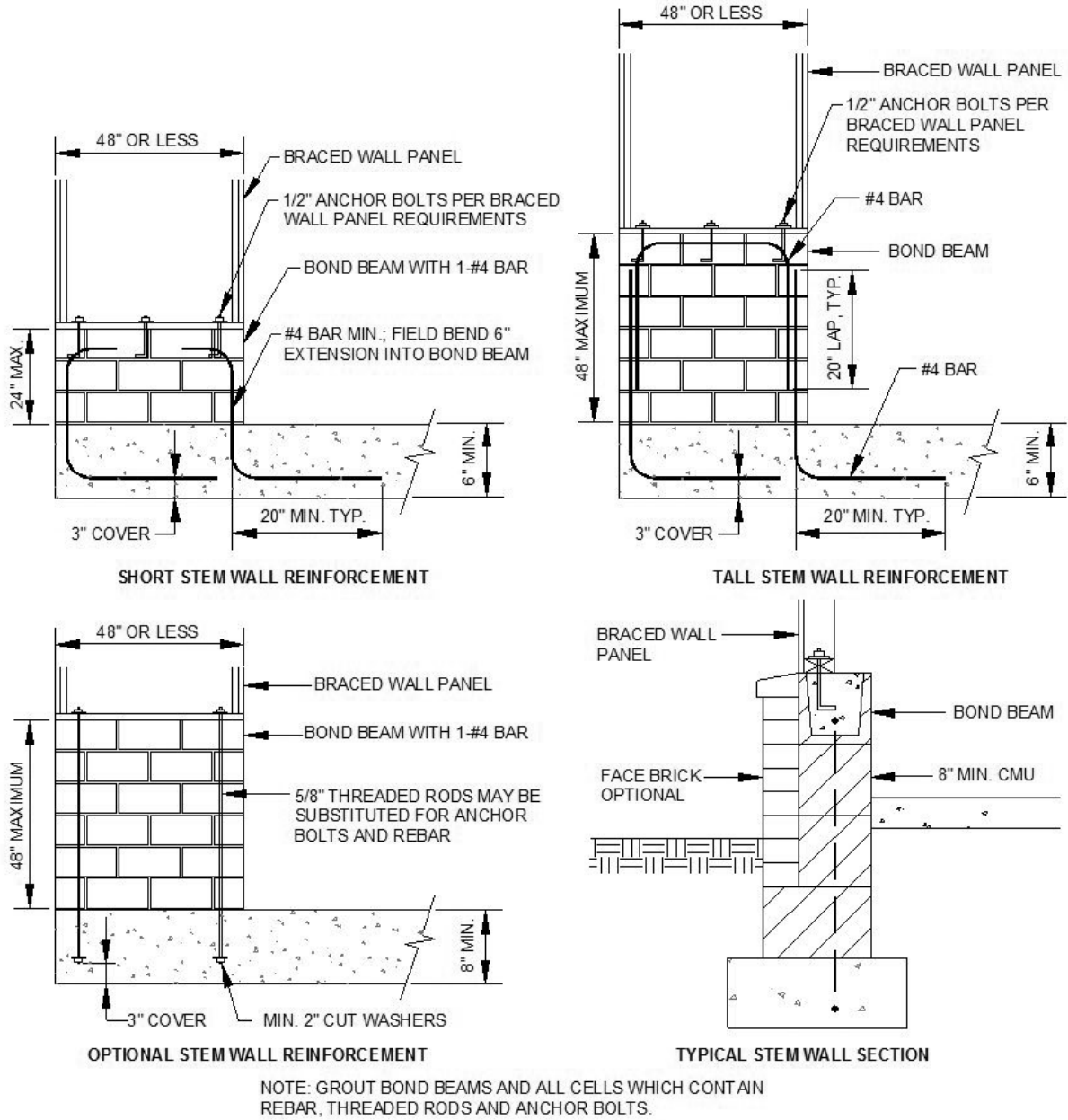
1. $\frac{5}{8}$ inch (16 mm) threaded rod – $\frac{3}{4}$ inch (19 mm) diameter hole with a minimum embedment of 6 inches (152 mm).
2. No. 4 reinforcing bar – $\frac{5}{8}$ inch (16 mm) diameter hole with a minimum embedment of $4\frac{1}{2}$ inches (114 mm).

A minimum footing thickness of 8 inches (203 mm) is required and the minimum distance from each anchor to the edge of the footing shall be $3\frac{3}{4}$ (95 mm).

The anchoring adhesive and anchors shall be installed in accordance with the manufacturer's instructions and have a minimum tensile capacity of 5,000 lbs (22 kN).

The reinforcement of the masonry stem wall and attachment of the braced wall panel to the stem wall shall be as shown in Figure R602.10.9.

R602.10.10 Panel joints. All vertical joints of panel sheathing shall occur over, and be fastened to common studs. Horizontal joints in



NOTE: GROUT BOND BEAMS AND ALL CELLS WHICH CONTAIN REBAR, THREADED RODS AND ANCHOR BOLTS.

For SI: 1 inch = 25.4 mm

**FIGURE R602.10.9
MASONRY STEM WALLS SUPPORTING BRACED WALL PANELS**

braced wall panels shall occur over, and be fastened to common blocking of a minimum 1 1/2 inch (38 mm) thickness.

Exceptions:

1. Vertical joints of panel sheathing shall be permitted to occur over double studs, where adjoining panel edges are attached to separate studs with the required panel edge fastening schedule, and the adjacent studs are attached together with 2 rows of 10d box nails (3 inch long x 0.128 inch diameter) at 10 inches (254 mm) o.c.

2. Blocking at horizontal joints shall not be required in wall segments that are not counted as braced wall panels.
3. Where the length of bracing provided is at least twice the required length of bracing from Tables R602.10.3(1) and R602.10.3(3) blocking at horizontal joints shall not be required in braced wall panels constructed using Methods WSP, SFB, GB, PBS or HPS.
4. When Method GB panels are installed horizontally, blocking of horizontal joints is not required.

R602.10.11 Cripple wall bracing. Cripple walls shall be constructed in accordance with Section R602.9 and braced in accordance with this section. Cripple walls shall be braced with the length and method of bracing used for the wall above in accordance with Tables R602.10.3(1) and R602.10.3(3), except that the length of cripple wall bracing shall be multiplied by a factor of 1.15.

R602.10.11.1 Cripple wall bracing for townhouses in Seismic Design Category C. In addition to the requirements in Section R602.10.11, the distance between adjacent edges of braced wall panels shall be 14 feet (4267 mm) maximum.

Where braced wall lines at interior walls are not supported on a continuous foundation below, the adjacent parallel cripple walls, where provided, shall be braced with Method WSP or CS-WSP per Section R602.10.4. The length of bracing required per Table R602.10.3(3) for the cripple walls shall be multiplied by 1.5. Where the cripple walls do not have sufficient length to provide the required bracing, the spacing of panel edge fasteners shall be reduced to 4 inches (102 mm) on center and the required bracing length adjusted by 0.7. If the required length can still not be provided, the cripple wall shall be designed in accordance with accepted engineering practice.

R602.10.11.2 Redesignation of cripple walls. Where all cripple wall segments along a braced wall line do not exceed 48 inches (1220 mm) in height, the cripple wall shall be permitted to be redesignated as a first story wall for purposes of determining wall bracing requirements. Where any cripple wall segment in a braced wall line exceeds 48 inches (1220 mm) in height, the entire cripple wall shall be counted as an additional story. If the cripple walls are redesignated, the stories above the redesignated story shall be counted as the second and third stories respectively.

50. Change Section R602.11.1 to read:

R602.11.1 Wall anchorage for townhouses in Seismic Design Category C. Plate washers, a minimum of 0.229 inch by 3 inches by 3 inches (5.8 mm by 76 mm by 76 mm) in size, shall be provided between the foundation sill plate and the nut except where approved anchor straps are used. The hole in the plate washer is permitted to be diagonally slotted with a width of up to $\frac{3}{16}$ inch (5 mm) larger than the bolt diameter and a slot length not to exceed $1\frac{3}{4}$ inches (44 mm), provided a standard cut washer is placed between the plate washer and the nut.

51. Delete Section R602.11.2.

52. Replace Section R602.12, including all subsections, with the following:

R602.12 Simplified wall bracing. Buildings meeting all of the conditions listed below shall be permitted to be braced in accordance with this section as an alternate to the requirements of Section R602.10. The entire building shall be braced in accordance with this section; the use of other bracing provisions of Section R602.10, except as specified herein, shall not be permitted.

1. There shall be no more than two stories above the top of a concrete or masonry foundation or basement wall. Permanent wood foundations shall not be permitted.
2. Floors shall not cantilever more than 24 inches (607 mm) beyond the foundation or bearing wall below.
3. Wall height shall not be greater than 10 feet (2743 mm).
4. The building shall have a roof eave-to-ridge height of 15 feet (4572 mm) or less.
5. All exterior walls shall have gypsum board with a minimum thickness of $\frac{1}{2}$ inches (12.7 mm) installed on the interior side fastened in accordance with Table R702.3.5.
6. The structure shall be located where the basic wind speed is less than or equal to 90 mph (40 m/s), and the Exposure Category is A or B.
7. The structure shall be located in Seismic Design Category of A, B or C for detached one- and two-family dwellings or Seismic Design Category A or B for townhouses.
8. Cripple walls shall not be permitted in two-story buildings.

R602.12.1 Circumscribed rectangle. Required bracing shall be determined by circumscribing a rectangle around the entire building on each floor as shown in Figure R602.12.1. The rectangle shall surround all enclosed offsets and projections such as sunrooms and attached garages. Open structures, such as carports and decks shall be permitted to be excluded. The rectangle shall have no side greater than 60 feet (18 288 mm), and the ratio between the long side and short side shall be a maximum of 3:1.

R602.12.2 Sheathing materials. The following sheathing materials installed on the exterior side of exterior walls shall be used to construct a bracing unit as defined in Section R602.12.3. Mixing materials is prohibited.

1. Wood structural panels with a minimum thickness of $\frac{3}{8}$ inch (9.5 mm) fastened in accordance with Table R602.3(3).

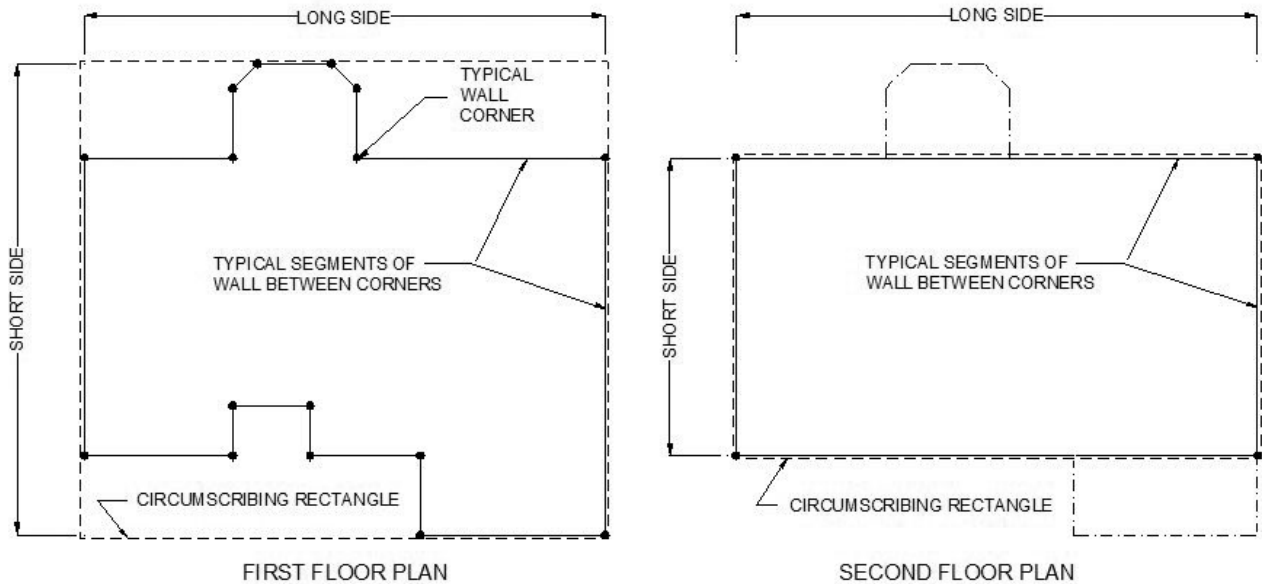


FIGURE R602.12.1
RECTANGLE CIRCUMSCRIBING AN ENCLOSED BUILDING

2. Structural fiberboard sheathing with a minimum thickness of $\frac{1}{2}$ inch (12.7 mm) fastened in accordance with Table R602.3(1).

R602.12.3 Bracing unit. A bracing unit shall be a full-height sheathed segment of the exterior wall with no openings or vertical or horizontal offsets and a minimum length as specified below. Interior walls shall not contribute toward the amount of required bracing. Mixing of Items 1 and 2 below is prohibited on the same story.

1. Where all framed portions of all exterior walls are sheathed in accordance with Section R602.12.2, including wall areas between bracing units, above and below openings and on gable end walls, the minimum length of a bracing unit shall be 3 feet (914 mm).
2. Where the exterior walls are braced with sheathing panels in accordance with Section R602.12.2 and areas between bracing units are covered with other materials, the minimum length of a bracing unit shall be 4 feet (1219 mm).

R602.12.3.1 Multiple bracing units. Segments of wall compliant with Section R602.12.3 and longer than the minimum bracing unit length shall be considered as multiple bracing units. The number of bracing units shall be determined by dividing the wall segment length by the minimum bracing unit length. Full-height sheathed segments of wall narrower than the minimum bracing unit length shall not contribute

toward a bracing unit except as specified in Section R602.12.6.

R602.12.4 Number of bracing units. Each side of the circumscribed rectangle, as shown in Figure R602.12.1, shall have, at a minimum, the number of bracing units per Table R602.12.4 placed on the parallel exterior walls facing the side of the rectangle. Bracing units shall then be placed using the distribution requirements specified in Section R602.12.5.

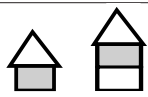

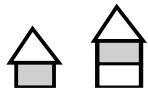

R602.12.5 Distribution of bracing units. The placement of bracing units on exterior walls shall meet all of the following requirements as shown in Figure R602.12.5.

1. A bracing unit shall begin no more than 12 feet (3658 mm) from any wall corner.
2. The distance between adjacent edges of bracing units shall be no greater than 20 feet (6096 mm).
3. Segments of wall greater than 8 feet (2438 mm) in length shall have a minimum of one bracing unit.

R602.12.6 Narrow panels. The bracing methods referenced in Section R602.10 and specified in Sections R602.12.6.1 through R602.12.6.3 shall be permitted when using simplified wall bracing.

R602.12.6.1 Method CS-G. Braced wall panels constructed as Method CS-G in accordance with Tables R602.10.4.1 and R602.10.5 shall be permitted for one-story garages when all framed portions of all exterior walls are sheathed with wood structural panels. Each CS-G panel shall be equivalent to 0.5 bracing units.

TABLE R602.12.4
MINIMUM NUMBER OF BRACING UNITS ON EACH SIDE OF THE CIRCUMSCRIBED RECTANGLE

STORY LEVEL	EAVE-TO RIDGE HEIGHT (feet)	MINIMUM NUMBER OF BRACING UNITS ON EACH LONG SIDE ^{a, b}						MINIMUM NUMBER OF BRACING UNITS ON EACH SHORT SIDE ^{a, b}					
		Length of short side (ft) ^c						Length of long side (ft) ^c					
		10	20	30	40	50	60	10	20	30	40	50	60
	10	1	2	2	2	3	3	1	2	2	2	3	3
			2	3	3	4	5	6	2	3	3	4	5
	15	1	2	3	3	4	4	1	2	3	3	4	4
			2	3	4	5	6	7	2	3	4	5	6

For SI: 1 foot = 304.8 mm.

- a. Interpolation shall not be permitted.
- b. Cripple walls or wood-framed basement walls in a walk-out condition of a one-story structure shall be designed as the first floor of a two-story house.
- c. Actual lengths of the sides of the circumscribed rectangle shall be rounded to the next highest unit of 10 when using this table.

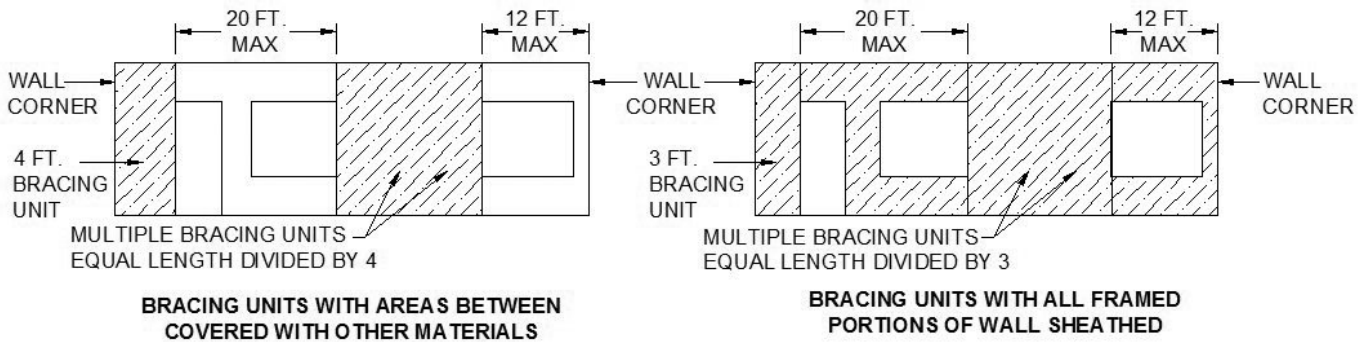


FIGURE R602.12.5
BRACING UNIT DISTRIBUTION

R602.12.6.2 Method CS-PF. Braced wall panels constructed as Method CS-PF in accordance with Section R602.10.6.4 shall be permitted when all framed portions of all exterior walls are sheathed with wood structural panels. Each CS-PF panel shall equal 0.5 bracing units. A maximum of four CS-PF panels shall be permitted on all the segments of walls parallel to each side of the circumscribed rectangle.

R602.12.6.3 Methods PFH and PFG. Braced wall panels constructed as Method PFH, in accordance with Section R602.10.6.2, and PFG, in accordance with Section R602.10.6.3, shall be permitted when bracing units are constructed using wood structural panels. Each PFH panel

shall equal one bracing unit, and each PFG shall equal 0.75 bracing units.

R602.12.7 Lateral support. For bracing units located along the eaves, the vertical distance from the outside edge of the top wall plate to the roof sheathing above shall not exceed 9.25 inches (235 mm) at the location of a bracing unit unless lateral support is provided in accordance with Section R602.10.8.1.

R602.12.8 Stem walls. Masonry stem walls with a height and length of 48 inches (1219 mm) or less supporting a bracing unit or a Method CS-G, CS-PF or PFG braced wall panel shall be constructed in accordance with Figure R602.10.9. Concrete stem walls greater than 12 inches (305 mm) tall and less than 6 inches (152 mm) thick shall have reinforcement sized and located in accordance with Figure R602.10.9.

53. Change Section R612.2 to read:

R612.2 Window sills. In dwelling units, where the opening of an operable window is located more than 72 inches (1829 mm) above the finished grade or surface below, the lowest part of the clear opening of the window shall be a minimum of 18 inches (457 mm) above the finished floor of the room in which the window is located. Operable sections of windows shall not permit openings that allow passage of a 4-inch-diameter (102 mm) sphere where such openings are located within 18 inches (457 mm) of the finished floor.

Exceptions:

1. Windows whose openings will not allow a 4-inch-diameter (102 mm) sphere to pass through the opening when the opening is in its largest opened position.
2. Openings that are provided with window fall prevention devices that comply with Section R612.3.
3. Openings that are provided with fall protection devices that comply with ASTM F 2090.
4. Windows that are provided with opening limiting devices that comply with Section R612.4.

54. Change Section R703.7 to read:

R703.7 Stone and masonry veneer, general. Stone and masonry veneer shall be installed in accordance with this chapter, Table R703.4 and Figure R703.7. These veneers installed over a backing of wood or cold-formed steel shall be limited to the first story above-grade and shall not exceed 5 inches (127 mm) in thickness. See Tables R602.10.3(3) and R602.10.3(4) for wall bracing requirements for masonry veneer for wood framed construction and Section R603.9.5 for wall bracing requirements for masonry veneer for cold-formed steel construction.

Exceptions:

1. For all buildings in Seismic Design Categories A, B and C, exterior stone or masonry veneer, as specified in Table R703.7(1), with a backing of wood or steel framing shall be permitted to the height specified in Table R703.7(1) above a noncombustible foundation.
2. For detached one- or two-family dwellings in Seismic Design Categories D₀, D₁ and D₂, exterior stone or masonry veneer, as specified in Table R703.7(2), with a backing of wood framing shall be permitted to the height specified in Table R703.7(2) above a noncombustible foundation.

55. Delete the reference to Note "f" and the footnote itself in Figure R802.11.

56. Delete Section N1101.9.

57. Change Section N1103.2.2 to read:

N1103.2.2 Sealing. All ducts, air handlers, filter boxes and building cavities used as ducts shall be sealed. Joints and seams shall comply with Section M1601.4.1 of the *International Residential Code*. Verification of compliance with this section shall be in accordance with either Section N1103.2.2.1 or Section N1103.2.2.2.

58. Add Section N1103.2.2.1 to read:

N1103.2.2.1 Testing option. Duct tightness shall be verified by either of the following:

1. Post-construction test: Leakage to outdoors shall be less than or equal to 8 cfm (3.78 L/s) per 100 ft² (9.29 m²) of conditioned floor area or a total leakage less than or equal to 12 cfm (5.66 L/s) per 100 ft² (9.29 m²) of conditioned floor area when tested at a pressure differential of 0.1 inch w.g. (25 Pa) across the entire system, including the manufacturer's air handler end closure. All register boots shall be taped or otherwise sealed during the test.
2. Rough-in test: Total leakage shall be less than or equal to 6 cfm (2.83 L/s) per 100 ft² (9.29 m²) of conditioned floor area when tested at a pressure differential of 0.1 inch w.g. (25 Pa) across the roughed in system, including the manufacturer's air handler enclosure. All register boots shall be taped or otherwise sealed during the test. If the air handler is not installed at the time of the test, total leakage shall be less than or equal to 4 cfm (1.89 L/s) per 100 ft² (9.29 m²) of conditioned floor area.

Exception: Duct tightness test is not required if the air handler and all ducts are located within conditioned space.

When this option is chosen, testing shall be performed by approved qualified individuals, testing agencies or contractors. Testing and results shall be as prescribed in Section N1103.2.2 and approved recognized industry standards.

59. Add Section N1103.2.2.2 to read:

N1103.2.2.2 Visual inspection option. In addition to the inspection of ducts otherwise required by this code, when the air handler and all ducts are not within conditioned space and this option is chosen to verify duct tightness, duct tightness shall be considered acceptable when the requirements of Section N1103.2.2 are field verified.

60. Change Section M1502.4.4.1 to read:

M1502.4.4.1 Specified length. The maximum length of the exhaust duct shall be 35 feet (10 668 mm) from the connection to the transition duct from the dryer to the outlet terminal. Where fittings are used the maximum length of the exhaust duct shall be reduced in accordance with Table M1502.4.4.1.

61. Add Section M1801.1.1 to read:

M1801.1.1 Equipment changes. Upon the replacement or new installation of any fuel-burning appliances or equipment in existing buildings, an inspection or inspections shall be conducted to ensure that the connected vent or chimney systems comply with the following:

1. Vent or chimney systems are sized in accordance with this code.
2. Vent or chimney systems are clean, free of any obstruction or blockages, defects or deterioration and are in operable condition.

Where not inspected by the local building department, persons performing such changes or installations shall certify to the building official that the requirements of Items 1 and 2 of this section are met.

62. Add Section G2425.1.1 to read:

G2425.1.1 Equipment changes. Upon the replacement or new installation of any fuel-burning appliances or equipment in existing buildings, an inspection or inspections shall be conducted to ensure that the connected vent or chimney systems comply with the following:

1. Vent or chimney systems are sized in accordance with this code.
2. Vent or chimney systems are clean, free of any obstruction or blockages, defects, or deterioration and are in operable condition.

Where not inspected by the local building department, persons performing such changes or installations shall certify to the building official that the requirements of Items 1 and 2 of this section are met.

63. Change Section P2601.2 to read:

P2601.2 Connections. Plumbing fixtures, drains and appliances used to receive or discharge liquid wastes or sewage shall be directly connected to the sanitary drainage system of the building or premises, in accordance with the requirements of this code. This section shall not be construed to prevent indirect waste systems.

Exception: Bathtubs, showers, lavatories, clothes washers and laundry trays are not required to discharge to the sanitary drainage system where those fixtures discharge to an approved gray water or rain water recycling system.

64. Change Section P2602.1 to read:

P2602.1 General. The water and drainage system of any building or premises where plumbing fixtures are installed shall be connected to a public or private water supply and a public or private sewer system. As provided for in Section 103.11 of Part I of the *Virginia Uniform Statewide Building Code* (13 VAC 5-63) for functional design, water supply sources and sewage disposal systems are regulated and approved by the Virginia Department of Health and the Virginia Department of Environmental Quality.

Note: See also the Memorandums of Agreement in the "Related Laws Package," which is available from the Virginia Department of Housing and Community Development.

65. Change Section P2903.5 to read:

P2903.5 Water hammer. The flow velocity of the water distribution system shall be controlled to reduce the possibility of water hammer. A water-hammer arrestor shall be installed where quick-closing valves are utilized, unless otherwise approved. Water hammer arrestors shall be installed in accordance with manufacturer's specifications. Water hammer arrestors shall conform to ASSE 1010.

66. Add Section P3002.2.1 to read:

P3002.2.1 Tracer wire. Nonmetallic sanitary sewer piping that discharges to public systems shall be locatable. An insulated copper tracer wire, 18 AWG minimum in size and suitable for direct burial or an equivalent product, shall be utilized. The wire shall be installed in the same trench as the sewer within 12 inches (305 mm) of the pipe and shall be installed from within 5 feet (1524 mm) of the building wall to the point where the building sewer intersects with the public system. At a minimum, one end of the wire shall terminate above grade in an accessible location that is resistant to physical damage, such as with a cleanout or at the building wall.

67. Add Section E3601.8 to read:

E3601.8 Energizing service equipment. The building official shall give permission to energize the electrical service equipment of a one- or two-family dwelling unit when all of the following requirements have been approved:

1. The service wiring and equipment, including the meter socket enclosure, shall be installed and the service wiring terminated.
2. The grounding electrode system shall be installed and terminated.
3. At least one receptacle outlet on a ground fault protected circuit shall be installed and the circuit wiring terminated.

4. Service equipment covers shall be installed.
5. The building roof covering shall be installed.
6. Temporary electrical service equipment shall be suitable for wet locations unless the interior is dry and protected from the weather.

68. Change Section E3802.4 to read:

E3802.4 In unfinished basements. Where type SE or NM cable is run at angles with joists in unfinished basements, cable assemblies containing two or more conductors of sizes 6 AWG and larger and assemblies containing three or more conductors of sizes 8 AWG and larger shall not require additional protection where attached directly to the bottom of the joists. Smaller cables shall be run either through bored holes in joists or on running boards. NM cable installed on the wall of an unfinished basement shall be permitted to be installed in a listed conduit or tubing or shall be protected in accordance with Table E3802.1. Conduit or tubing shall be provided with a suitable insulating bushing or adapter at the point where cable enters the raceway. The NM or SE cable sheath shall extend through the conduit or tubing and into the outlet or device box not less than 1/4 inch (6.4 mm). The cable shall be secured within 12 inches (305 mm) of the point where the cable enters the conduit or tubing. Metal conduit, tubing, and metal outlet boxes shall be connected to an equipment grounding conductor.

69. Change Section E3902.11 to read:

E3902.11 Arc-fault protection of bedroom outlets. All branch circuits that supply 120-volt, single phase, 15- and 20-ampere outlets installed in bedrooms shall be protected by a combination type arc-fault circuit interrupter installed to provide protection of the branch circuit.

Exceptions:

1. Where a combination AFCI is installed at the first outlet to provide protection for the remaining portion of the branch circuit, the portion of the branch circuit between the branch-circuit overcurrent device and such outlet shall be wired with metal outlet and junction boxes and RMC, IMC, EMT or steel armored cable, Type AC meeting the requirements of Section E3908.8.
2. AFCI protection is not required for a branch circuit supplying only a fire alarm system where the branch circuit is wired with metal outlet and junction boxes and RMC, IMC, EMT or steel armored cable Type AC meeting the requirements of Section E3908.8.

SECTION 311 STORAGE GROUP S

311.1 Storage Group S. Storage Group S occupancy includes, among others, the use of a building or structure, or a portion thereof, for storage that is not classified as a hazardous occupancy.

311.2 Moderate-hazard storage, Group S-1. Buildings occupied for storage uses that are not classified as Group S-2, including, but not limited to, storage of the following:

- Aerosols, Levels 2 and 3
- Aircraft hangar (storage and repair)
- Bags: cloth, burlap and paper
- Bamboos and rattan
- Baskets
- Belting: canvas and leather
- Books and paper in rolls or packs
- Boots and shoes
- Buttons, including cloth covered, pearl or bone
- Cardboard and cardboard boxes
- Clothing, woolen wearing apparel
- Cordage
- Dry boat storage (indoor)
- Furniture
- Furs
- Glues, mucilage, pastes and size
- Grains
- Horns and combs, other than celluloid
- Leather
- Linoleum
- Lumber
- Motor vehicle repair garages complying with the maximum allowable quantities of hazardous materials listed in Table 307.1(1) (see Section 406.6)
- Photo engravings
- Resilient flooring
- Silks
- Soaps
- Sugar
- Tires, bulk storage of
- Tobacco, cigars, cigarettes and snuff
- Upholstery and mattresses
- Wax candles

311.3 Low-hazard storage, Group S-2. Includes, among others, buildings used for the storage of noncombustible materials such as products on wood pallets or in paper cartons with or without single thickness divisions; or in paper wrappings. Such products are permitted to have a negligible amount of plastic trim, such as knobs, handles or film wrapping. Group S-2 storage uses shall include, but not be limited to, storage of the following:

- Asbestos
- Beverages up to and including 16-percent alcohol in metal, glass or ceramic containers
- Cement in bags
- Chalk and crayons
- Dairy products in nonwaxed coated paper containers
- Dry cell batteries
- Electrical coils

USE AND OCCUPANCY CLASSIFICATION

Electrical motors
Empty cans
Food products
Foods in noncombustible containers
Fresh fruits and vegetables in nonplastic trays or containers
Frozen foods
Glass
Glass bottles, empty or filled with noncombustible liquids
Gypsum board
Inert pigments
Ivory
Meats
Metal cabinets
Metal desks with plastic tops and *trim*
Metal parts
Metals
Mirrors
Oil-filled and other types of distribution transformers
Parking garages, open or enclosed
Porcelain and pottery
Stoves
Talc and soapstones
Washers and dryers

SECTION 312 UTILITY AND MISCELLANEOUS GROUP U

312.1 General. Buildings and structures of an accessory character and miscellaneous structures not classified in any specific occupancy shall be constructed, equipped and maintained to conform to the requirements of this code commensurate with the fire and life hazard incidental to their occupancy. Group U shall include, but not be limited to, the following:

Agricultural buildings
Aircraft hangars, accessory to a one- or two-family residence (see Section 412.5)
Barns
Carports
Fences more than 6 feet (1829 mm) high
Grain silos, accessory to a residential occupancy
Greenhouses
Livestock shelters
Private garages
Retaining walls
Sheds
Stables
Tanks
Towers